



PRODUCT CATALOG

LEAVE LIMITS BEHIND

Introduction

About ADIN	3
Dental Implant Systems	4
Surface Treatments	5

Internal Conical Connection Implant Systems

CloseFit™ Implant Systems	6-7
---------------------------	-----

UNP CloseFit™

UNP Implant Systems	8
UNP Prosthetics & Tools	9-11

NP CloseFit™

NP Implant Systems	12
NP Prosthetics & Tools	13-16

RP CloseFit™

RP Implant System	18
RP Prosthetics & Tools	19-23

WP CloseFit™

WP Implant System	24-25
WP Prosthetics & Tools	26-30

Standard Internal Hex Connection Implant Systems

Touareg™-OS & Touareg™-S Implant Systems	32-33
Touareg™-OS	34-38
Touareg™-S	39-43
Swell™	44-49
Standard Internal Hex Prosthetic & Tools	50-55

One Piece Implant System

One™	56-61
------	-------

Surgical Kits & Tools

CloseFit™ Surgical Kit	62-63
Touareg™ RS- Standart Internal Hex Surgical Kit	64-65
Prosthetic Kit	66
Tools	67-70
Surgical Drills & Drill Stoppers	72-73

Index

In Alphabetical Order	74-79
In Numerical Order	79-84

ADIN provides all dental professionals with state-of-the-art product and service performance that enhances their expertise.

With its products in the market since 1992, ADIN Dental Implant Systems Ltd. is a global leader in the design and manufacturing of dental implant solutions.

ADIN stands for:

R&D and Product Innovation

Since its inception, ADIN has continuously focused on driving its highly professional Research and Development team to design and develop innovative, technologically-advanced, high-quality products. Our R&D relies on close collaboration with the industry's leading dental professionals, surgeons and technicians, in both private and public sectors, along with dental schools within leading universities.

Uncompromising Service

ADIN prides itself on providing excellent customer service and constant availability to thousands of dental professionals in over 60 countries worldwide. When using ADIN, a “next door” level of service is being kept for both logistical, technical and clinical inquiries, regardless of your location or the nature of your request.

People for People

Each of our employees see themselves personally committed to the complete satisfaction of each and every one of our users worldwide, putting the needs of both clinicians and patients at the top of their priorities.

A Balance of Excellence

At ADIN, it all comes down to the ability to design and manufacture the best possible product and distribute it at the most reasonable price.

This “balance of excellence”, where top-notch products & services and affordable prices meet, is what makes ADIN the preferred choice for the widest range of members of the dental community.

**ADIN. Dedicated to Your Success,
All Over the World.**

CloseFit™ Implant System

Conical Hex Connection with OsseoFix™ - Calcium Phosphate Blasted Surface Treatment

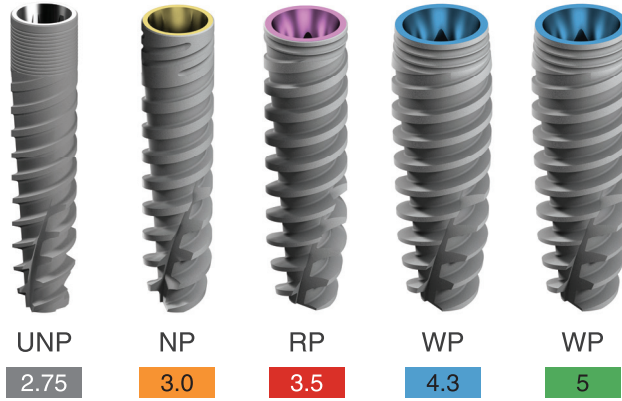

Actual color of implant platforms

Packaging implant diameter color code

Standard Internal Hex Implant Systems

Touareg™-OS

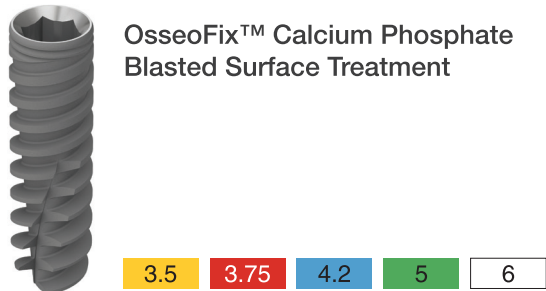

Touareg™-S

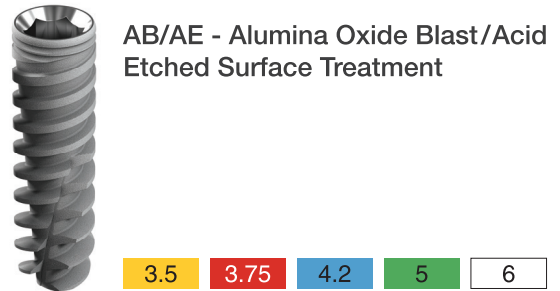

SWELL™

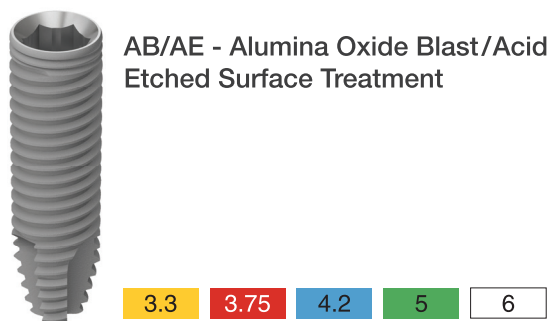

ONE™

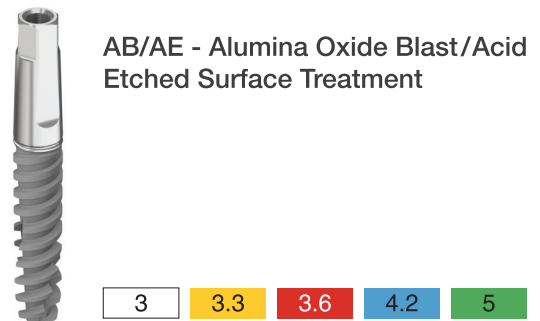

OsseoFix™

Over the past 15 years, ADIN has followed several research studies conducted in order to discover the optimal implant surface treatment. Proper implant surface technique is needed to attain correct surface roughness and the highest purity levels in order to achieve optimal osseointegration, increase the success rate of Bone to Implant Contact (BIC) and increase the healing process and tissue growth around the implant while eliminating the possibility of infections post-surgery.

ADIN has developed a highly successful implant surface treatment called OsseoFix™. OsseoFix™ is a pure titanium implant surface that uses calcium phosphate, a biocompatible resorbable blast media (RBM), that is debris free and has been proven to achieve the desired roughness levels needed for optimal osseointegration and attain the highest implant surface purity levels. The chemical composition of the OsseoFix™ surface is enriched with calcium, phosphorus and oxygen. The OsseoFix™ surface treatment is biocompatible and osseoconductive.

OsseoFix™ Surface Treatment Advantages:

- Biocompatible resorbable material creates a pure and clean surface texture
- Accelerates the healing process
- Increases optimal osseointegration
- Increases long term success

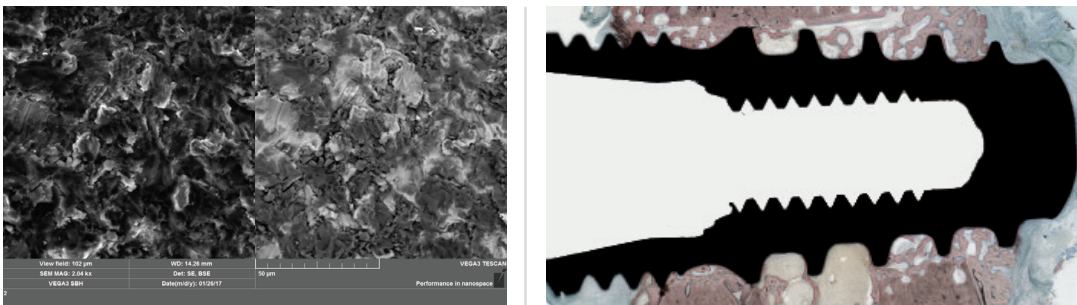

AB/AE (SLA™*) -

Alumina Oxide Blasted Large Grit Followed by Acid Etch

AB/AE surface treatment involves blasting with large grit aluminum oxide particles followed by acid etching with sulfuric and hydrochloric acid to remove the embedded particles.

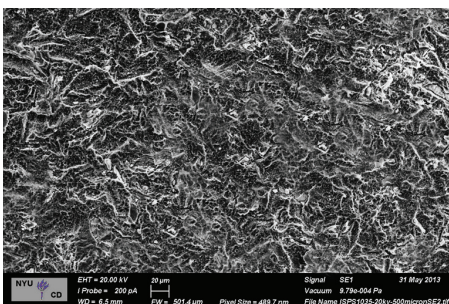

* Institut Straumann AG's trademark

CloseFit™

UNP CloseFit™

Ø 2.75mm

Narrow Platform for
Narrow Ridges
and Tight Spaces

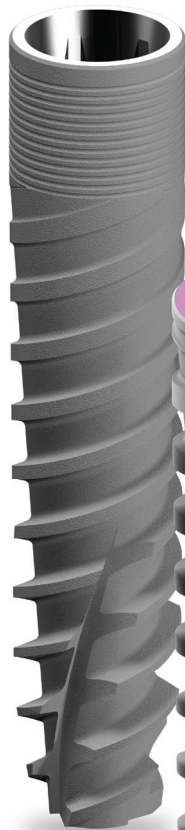

NP CloseFit™

Ø 3.0mm

Narrow Platform for
Narrow Ridges
and Tight Spaces

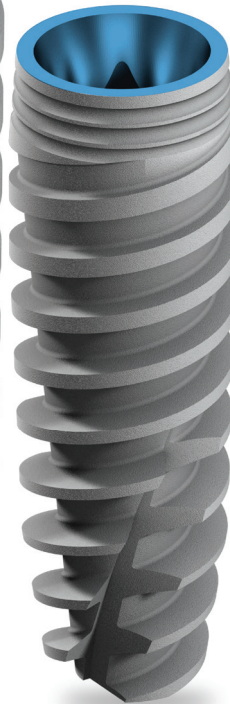
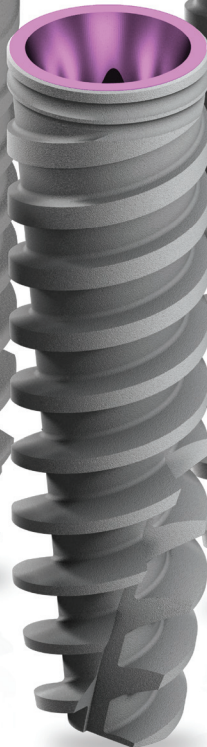

RP CloseFit™

Ø 3.5mm

Regular Platform
for Standard Size
Ridges and Spaces

WP CloseFit™

Ø 4.3 / 5.0mm

Wide Platform
for Wide / Large
Ridges and Spaces

ADIN's CloseFit™ Conical Hex Connection

The CloseFit™ spiral implant system offers a unique, strong and solid conical-hex connection. The conical-hex connection enables implants to be used in all indications and regions in the lower and upper jaw. The Morse Taper Connection minimizes micro movements between the implant and abutment.

The CloseFit™ spiral implant system is comprised of a tapered core implant with a spiral tap, promoting increased immediate stability. With their unique tip and double lead thread design (2x1.2mm), these implants slice through bone unlike conventional self-tapping implants, which scrape the bone away as they tap.

By repositioning bone as it is being inserted, CloseFit™ implants can be placed at different angles for exceptional primary stability and optimal restorative orientation, along with improved esthetics and a better loading distribution.

All CloseFit™ implants feature the OsseoFix™ surface treatment proven to achieve the desired roughness levels needed for optimal osseointegration, increase the rate of Bone to Implant Contact (BIC) and attain the highest implant surface purity levels.

CloseFit™ Advantages:

- Osseofix™ Surface Treatment
- High Primary Stability, Even in Type IV Bone
- Self-Tapping
- Double Lead Threads (2 X 1.2mm), UNP: Triple Lead Threads (3 X 1mm)
- Redirecting Capability for more Accurate Implant Placement
- Built-In Platform Switching
- Strong CloseFit™ Connection
- Requires Minimally Invasive Surgery
- Immediate Function / Loading Capability in all Bone Types

* Note: These statements are not cleared for US market.

	L-8mm	L-10mm	L-11.5mm	L-13mm	L-15mm	L-16mm	L-18mm
UNP-Ø2.75mm		ISPUNP1027	ISPUNP1127	ISPUNP1327		ISPUNP1627	ISPUNP1827
NP-Ø3.0mm		ISPNP1030	ISPNP1130	ISPNP1330		ISPNP1630	ISPNP1830
RP-Ø3.5mm	ISPX0835	ISPX1035	ISPX1135	ISPX1335	ISPX1535		ISPX1835
WP-Ø4.3mm	ISPX0843	ISPX1043	ISPX1143	ISPX1343	ISPX1543		ISPX1843
WP-Ø5.0mm	ISPX0849	ISPX1049	ISPX1149	ISPX1349	ISPX1549		ISPX1849

UNP CloseFit™ Ø2.75

OsseoFix™ Surface
Titanium Alloy - Ti 6Al 4V ELI

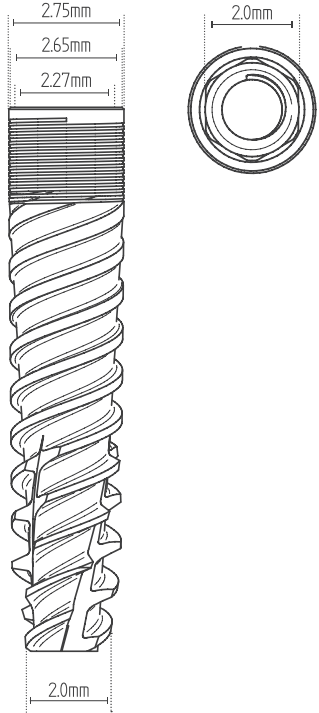
Catalog No.	Length mm		
ISPUNP1027	10		
ISPUNP1127	11.5		
ISPUNP1327	13		
ISPUNP1627	16		
ISPUNP1827	18		

Drill Sequence

FOR ALL BONE TYPE
2.5

Note: (x.xx) drill to the depth of the cortex only. All measurements are in mm.





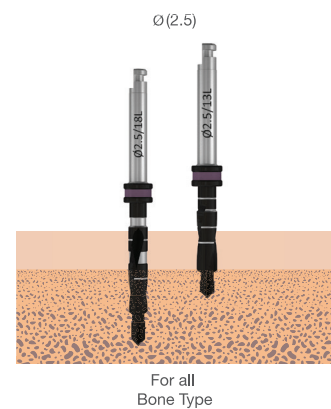

⚠ CAUTION: The drill preparation is up to 1mm longer than the implant.

* The drill apical step = 1.8mmD.















Radiographic Template





Healing Abutments & Cover Screw

	UNP0073	UNP Conical Cover Screw	Ti 6Al 4V ELI
	UNP0046	UNP Slim Healing Abutment 2.75mmDX2mmL	Ti 6Al 4V ELI
	UNP0047	UNP Slim Healing Abutment 2.75mmDX3mmL	Ti 6Al 4V ELI
	UNP0048	UNP Slim Healing Abutment 2.75mmDX4mmL	Ti 6Al 4V ELI
	UNP0049	UNP Slim Healing Abutment 2.75mmDX5mmL	Ti 6Al 4V ELI
	UNP0050	UNP Slim Healing Abutment 2.75mmDX6mmL	Ti 6Al 4V ELI
	UNP0004	UNP Healing Abutment 4mmDX2mmL	Ti 6Al 4V ELI
	UNP0008	UNP Healing Abutment 4mmDX3mmL	Ti 6Al 4V ELI
	UNP0009	UNP Healing Abutment 4mmDX4mmL	Ti 6Al 4V ELI
	UNP0012	UNP Healing Abutment 4mmDX5mmL	Ti 6Al 4V ELI
	UNP0013	UNP Healing Abutment 4mmDX6mmL	Ti 6Al 4V ELI
	UNP0090	UNP Conical Healing Abutment 4mmDX2mmL	Ti 6Al 4V ELI
	UNP0091	UNP Conical Healing Abutment 4mmDX3mmL	Ti 6Al 4V ELI
	UNP0092	UNP Conical Healing Abutment 4mmDX4mmL	Ti 6Al 4V ELI
	UNP0093	UNP Conical Healing Abutment 4mmDX5mmL	Ti 6Al 4V ELI
	UNP0094	UNP Conical Healing Abutment 4mmDX6mmL	Ti 6Al 4V ELI

Cement Retained Abutments

	UNP0010	UNP Straight Slim Abutment - No End Line	Ti 6Al 4V ELI
	UNP0019	UNP Straight Abutment - 1mm	Ti 6Al 4V ELI
	UNP0011	UNP Straight Abutment - 2mm	Ti 6Al 4V ELI
	UNP0064	UNP Straight Abutment - 3mm	Ti 6Al 4V ELI
	UNP0018	UNP Angled Abutment 15° - No End Line	Ti 6Al 4V ELI
	UNP0063	UNP Angled Abutment 15° 1mm	Ti 6Al 4V ELI
	UNP0015	UNP Angled Abutment 15° 2mm	Ti 6Al 4V ELI
	UNP0026	UNP Angled Abutment 15° 3mm	Ti 6Al 4V ELI
	UNP0043	UNP Engaging Temporary Abutment	Ti 6Al 4V ELI
	UNP0044	UNP Non Engaging Temporary Abutment	Ti 6Al 4V ELI
	UNP0045	UNP Engaging Plastic Cylinder Abutment	POM
	UNP0080	UNP Esthetic Abutment 1mm	Ti 6Al 4V ELI

Cement Retained Abutments

	UNP0081	UNP Esthetic Abutment 2mm	Ti 6Al 4V ELI
	UNP0082	UNP Esthetic Abutment 3mm	Ti 6Al 4V ELI
	UNP3812	UNP One Piece Screw-In Abutment 1mm	Ti 6Al 4V ELI
	UNP3813	UNP One Piece Screw-In Abutment 2mm	Ti 6Al 4V ELI
	UNP3814	UNP One Piece Screw-In Abutment 3mm	Ti 6Al 4V ELI





Ball Attachment - Overdentures

	UNP0020	UNP Ball Attachment 0.5mm	Ti 6Al 4V ELI
	UNP0021	UNP Ball Attachment 1mm	Ti 6Al 4V ELI
	UNP0022	UNP Ball Attachment 2mm	Ti 6Al 4V ELI
	UNP0023	UNP Ball Attachment 3mm	Ti 6Al 4V ELI
	UNP0024	UNP Ball Attachment 4mm	Ti 6Al 4V ELI
	UNP0025	UNP Ball Attachment 5mm	Ti 6Al 4V ELI
	RS2660	Plastic Ball Cap White	Nylon
	RS2662	Plastic Ball Cap Pink Soft	Nylon
	RS2670	Titanium Ball Cap	Ti 6Al 4V ELI

Analog

	UNP0007	UNP Implant Analog	Stainless Steel
---	---------	--------------------	-----------------





Transfers / Impression Coping

	UNP5113	UNP Slim Closed Tray Transfer 3.2mmDx13mmL	Ti 6Al 4V ELI
	UNP5213	UNP Closed Tray Transfer 4.0mmDx13mmL	Ti 6Al 4V ELI
	UNP5614	UNP Slim Open Tray Transfer 3.2mmDx14mmL	Ti 6Al 4V ELI
	UNP5514	UNP Open Tray Transfer 4mmDx14mmL	Ti 6Al 4V ELI

* Transfers can be tightened by Star Driver.



* Transfers will be chosen by length and width according to the planned prosthetic treatment and according to the interocclusal distance.

UNP Screws





	UNP0073	UNP Conical Cover Screw	Ti 6Al 4V ELI
	UNP0001	UNP Abutment Screw	Ti 6Al 4V ELI
	UNP5127	UNP Closed Tray Transfer Screw	Ti 6Al 4V ELI
	UNP5014	UNP Open Tray Transfer Screw	Ti 6Al 4V ELI

* All systems are provided with their compatible screws. However, they may also be ordered individually.

Hand Drivers

	RP0064	Star Hand Driver - Short	Stainless Steel
	RP0004	Star Hand Driver - Long	Stainless Steel

Torque Drivers

	UNP1001	UNP/NP Abutment Insertion Tool	Stainless Steel
	RP0065	Star Torque Driver - Short	Stainless Steel
	RP0005	Star Torque Driver - Long	Stainless Steel
	RA0050	Wrench Ratchet Surgical Instruments Handle * use with UNP0068/ UNP0071/ UNP0074	Stainless Steel

Handpiece Drivers and Adaptors

	UNP0068	UNP 2mm Hex Handpiece Adapter - Short	Stainless Steel
	UNP0071	UNP 2mm Hex Handpiece Adapter - Medium	Stainless Steel
	UNP0074	UNP 2mm Hex Handpiece Adapter - Long	Stainless Steel
	RP0018	Star Handpiece Driver - Short	Stainless Steel
	RP0019	Star Handpiece Driver - Long	Stainless Steel

NP CloseFit™ Ø3.0

OsseoFix™ Surface
Titanium Alloy - Ti 6Al 4V ELI

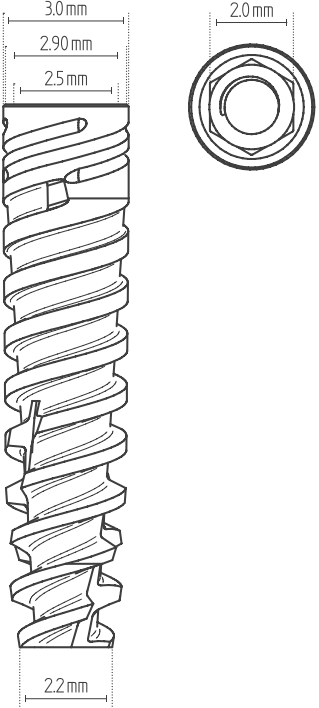
Catalog No.	Length mm		
ISPNP1030	10		
ISPNP1130	11.5		
ISPNP1330	13		
ISPNP1630	16		
ISPNP1830	18		

Drill Sequence

BONE TYPE D-IV	BONE TYPE D-II & III	BONE TYPE D-I
1. 2.0	1. 2.0 2. (2.8)	1. 2.0 2. 2.8

Note: (x.xx) drill to the depth of the cortex only. All measurements are in mm.

⚠ CAUTION: The drill preparation is up to 1mm longer than the implant.

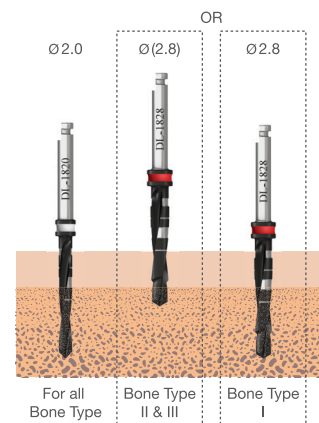





Radiographic Template



Healing Abutments & Cover Screw

	NP0073	NP Conical Implant Cover Screw	Ti 6Al 4V ELI
	NP0046	NP Slim Healing Abutment 3mmD x 2mmL	Ti 6Al 4V ELI
	NP0047	NP Slim Healing Abutment 3mmD x 3mmL	Ti 6Al 4V ELI
	NP0048	NP Slim Healing Abutment 3mmD X 4mmL	Ti 6Al 4V ELI
	NP0049	NP Slim Healing Abutment 3mmD X 5mmL	Ti 6Al 4V ELI
	NP0050	NP Slim Healing Abutment 3mmD X 6mmL	Ti 6Al 4V ELI
	NP0004	NP Healing Abutment 4.5mmD X 2mmL	Ti 6Al 4V ELI
	NP0008	NP Healing Abutment 4.5mmD X 3mmL	Ti 6Al 4V ELI
	NP0009	NP Healing Abutment 4.5mmD X 4mmL	Ti 6Al 4V ELI
	NP0012	NP Healing Abutment 4.5mmD X 5mmL	Ti 6Al 4V ELI
	NP0013	NP Healing Abutment 4.5mmD X 6mmL	Ti 6Al 4V ELI
	NP0090	NP Conical Healing Abutment 4.5mmD x 2mmL	Ti 6Al 4V ELI
	NP0091	NP Conical Healing Abutment 4.5mmD x 3mmL	Ti 6Al 4V ELI
	NP0092	NP Conical Healing Abutment 4.5mmD x 4mmL	Ti 6Al 4V ELI
	NP0093	NP Conical Healing Abutment 4.5mmD x 5mmL	Ti 6Al 4V ELI
	NP0094	NP Conical Healing Abutment 4.5mmD x 6mmL	Ti 6Al 4V ELI

Cement Retained

	NP0010	NP Straight Slim Abutment - No End Line	Ti 6Al 4V ELI
	NP0019	NP Straight Abutment 1mm	Ti 6Al 4V ELI
	NP0011	NP Straight Abutment 2mm	Ti 6Al 4V ELI
	NP0064	NP Straight Abutment 3mm	Ti 6Al 4V ELI
	NP0018	NP Angled Abutment 15° - No End Line	Ti 6Al 4V ELI
	NP0015	NP Angled Abutment 15° 1mm	Ti 6Al 4V ELI
	NP0026	NP Angled Abutment 15° 2mm	Ti 6Al 4V ELI
	NP0063	NP Angled Abutment 15° 3mm	Ti 6Al 4V ELI
	NP0025	NP Angled Abutment 25° - No End Line	Ti 6Al 4V ELI
	NP0043	NP Engaging Temporary Abutment	Ti 6Al 4V ELI
	NP0044	NP Non Engaging Temporary Abutment	Ti 6Al 4V ELI
	NP0045	NP Engaging Plastic Cylinder Abutment	POM

Cement Retained











	NP3095	NP Engaging Titanium / Plastic Abutment	Ti 6Al 4V ELI / POM
	NP3097	NP Non Engaging Titanium / Plastic Abutment	Ti 6Al 4V ELI / POM

Screw Retained - MU Trans Mucosal Abutments (TMA™)

	NP0032	NP Straight Trans Mucosal Abutment 1mm	Ti 6Al 4V ELI
	NP0033	NP Straight Trans Mucosal Abutment 2mm	Ti 6Al 4V ELI
	NP0034	NP Straight Trans Mucosal Abutment 3mm	Ti 6Al 4V ELI
	NP3729	NP Straight Trans Mucosal Abutment 4mm	Ti 6Al 4V ELI
	NP3730	NP Straight Trans Mucosal Abutment 5mm	Ti 6Al 4V ELI
	NP0035	NP Angled Trans Mucosal Abutment 17° 3mmL	Ti 6Al 4V ELI
	NP0038	NP Angled Trans Mucosal Abutment 17° 4mmL	Ti 6Al 4V ELI
	NP0036	NP Angled Trans Mucosal Abutment 30° 3.5mmL	Ti 6Al 4V ELI
	NP0037	NP Angled Trans Mucosal Abutment 30° 5mmL	Ti 6Al 4V ELI
	RS5005	TMA Healing Cap	Ti 6Al 4V ELI
	RS4900	TMA Titanium Temporary Cylinder	Ti 6Al 4V ELI
	RS5001	TMA Plastic Casting Sleeve w / Prosthetic Screw	POM
	RS5004	TMA Abutment Replica	Stainless Steel
	RS5006	TMA Open Tray Transfer	Ti 6Al 4V ELI
	RS5011	TMA Closed Tray Transfer	Ti 6Al 4V ELI

* The term "impression coping" has been amended to the term "transfer" (the terms are synonymous). Please note that either term may appear in different documentation.



Screw Retained - Flat Connection

	NP0030	NP Flat Connection Abutment 2mm	Ti 6Al 4V ELI
	NP0031	NP Flat Connection Abutment 4mm	Ti 6Al 4V ELI
	FC5515	Flat Connection Temporary Cylinder Sleeve	Ti 6Al 4V ELI
	FC5737	Flat Connection Implant Replica	Stainless Steel
	FC6011	Flat Connection Castable Abutment for Centering Ring	POM
	FC6015	Flat Connection Titanium Retaining Screw	Ti 6Al 4V ELI
	FC6013	Flat Connection Titanium Gluing Ring	Ti 6Al 4V ELI
	FC6017	Flat Connection Long Laboratory Screw	Ti 6Al 4V ELI
	FC6018	Flat Connection Centering Ring	Ti 6Al 4V ELI
	FC5512	Flat Connection Transfer	Ti 6Al 4V ELI





Ball Attachment - Overdentures

	NP0020	NP Ball Attachment 0.5mm	Ti 6Al 4V ELI
	NP0021	NP Ball Attachment 1mm	Ti 6Al 4V ELI
	NP0022	NP Ball Attachment 2mm	Ti 6Al 4V ELI
	NP0023	NP Ball Attachment 3mm	Ti 6Al 4V ELI
	NP0024	NP Ball Attachment 4mm	Ti 6Al 4V ELI
	RS2660	Plastic Ball Cap White	Nylon
	RS2662	Plastic Ball Cap Pink Soft	Nylon
	RS2670	Titanium Ball Cap	Ti 6Al 4V ELI
	RS2675SS	Stainless Steel Ball Cap	Stainless Steel

Analogs

	NP0007	NP Implant Analog	Stainless Steel
	RS5740	Ball Attachment Abutment Replica	Stainless Steel











Transfers / Impression Coping

	NP5113	NP Slim Closed Tray Transfer 3.2mmDx13mmL	Ti 6Al 4V ELI
	NP5213	NP Closed Tray Transfer 4.2mmDx13mmL	Ti 6Al 4V ELI
	NP5614	NP Slim Open Tray Transfer 3.2mmDx14mmL	Ti 6Al 4V ELI
	NP5514	NP Open Tray Transfer 4.2mmDx14mmL	Ti 6Al 4V ELI

* Transfers can be tightened by Star Driver.





* Transfers will be chosen by length and width according to the planned prosthetic treatment and according to the interocclusal distance.

NP Screws









	NP0073	NP Conical Implant Cover Screw	Ti 6Al 4V ELI
	NP0001	NP Abutment Screw	Ti 6Al 4V ELI
	NP0039	NP Retaining Screw for TMA 1mm	Ti 6Al 4V ELI
	NP0040	NP Retaining Screw for TMA 2mm	Ti 6Al 4V ELI
	NP0041	NP Retaining Screw for TMA 3mm	Ti 6Al 4V ELI
	NP3409	NP Retaining Screw for TMA 4mm	Ti 6Al 4V ELI
	NP3412	NP Retaining Screw for TMA 5mm	Ti 6Al 4V ELI
	NP0042	NP Retaining Screw for Angled TMA	Ti 6Al 4V ELI
	NP5014	NP Open Tray Transfer Screw	Ti 6Al 4V ELI
	NP5127	NP Closed Tray Transfer Screw	Ti 6Al 4V ELI
	NP0014	NP Retrieval Screw for Abutments	Ti 6Al 4V ELI

* All systems are provided with their compatible screws. However, they may also be ordered individually.

Hand Drivers

	RP0064	Star Hand Driver - Short	Stainless Steel
	RP0004	Star Hand Driver - Long	Stainless Steel
	RS6193	TMA/FC Female Hand Hex Driver - Short	Stainless Steel
	RS6191	TMA/FC Female Hand Hex Driver - Long	Stainless Steel
	NP0014	NP Retrieval Screw for Abutments	Ti 6Al 4V ELI

Torque Drivers

	UNP1001	UNP/NP Abutment Insertion Tool	Stainless Steel
	NP0006	NP 2mm Torque Driver - Short	Stainless Steel
	NP0005	NP 2mm Torque Driver - Long	Stainless Steel
	RP0065	Star Torque Driver - Short	Stainless Steel
	RP0005	Star Torque Driver - Long	Stainless Steel
	RS6090	Torque Driver for Ball Attachment	Stainless Steel
	RS6197	TMA/FC Hex Torque Driver - Short	Stainless Steel
	RS6196	TMA/FC Hex Torque Driver - Long	Stainless Steel
	RA0050	Wrench Ratchet Surgical Instruments Handle	Stainless Steel

* use with NP0068/ NP0071/ NP0074

Handpiece Drivers and Adaptors

	NP0068	NP 2mm Hex Handpiece Adapter - Short 24mm	Stainless Steel
	NP0071	NP 2mm Hex Handpiece Adapter - Medium 28mm	Stainless Steel
	NP0074	NP 2mm Hex Handpiece Adapter - Long 36mm	Stainless Steel
	NP0062	NP 2mm Hex Handpiece Adapter - Short 20mm	Stainless Steel
	NP0072	NP 2mm Hex Handpiece Adapter - Long 25mm	Stainless Steel
	RP0018	Star Handpiece Driver - Short	Stainless Steel
	RP0019	Star Handpiece Driver - Long	Stainless Steel
	RS6194	TMA/FC Hex Handpiece Adapter - Short	Stainless Steel
	RS6195A	TMA/FC Hex Handpiece Adapter - Long	Stainless Steel

Predictable



RP CloseFit™ Ø3.5

OsseoFix™ Surface
Titanium Alloy - Ti 6Al 4V ELI

Catalog No.	Length mm		
ISPX0835	8		
ISPX1035	10		
ISPX1135	11.5		
ISPX1335	13		
ISPX1535	15		
ISPX1835	18		

Drill Sequence

BONE TYPE D-IV	BONE TYPE D-II & III	BONE TYPE D-I
1. Tri-Step*	1. Tri-Step* 2. (3.2)	1. Tri-Step* 2. (3.2)

Note: (x.xx) drill to the depth of the cortex only. All measurements are in mm.

⚠ CAUTION: The drill preparation is up to 1mm longer than the implant.

* For initial drilling, you may use 2, 2.8 and 3.2 drills in sequence instead of the Tri-Step drill.

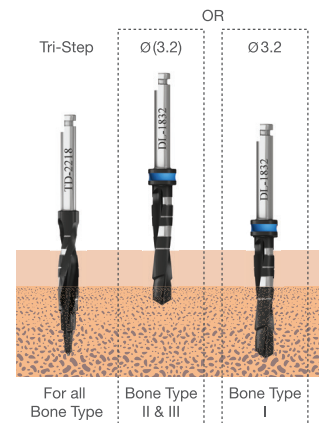

Radiographic Template







Healing Abutments & Cover Screw

	RP0073	RP Conical Implant Cover Screw	Ti 6Al 4V ELI
	RP0046	RP Slim Healing Abutment 3.5mmD x 2mmL	Ti 6Al 4V ELI
	RP0047	RP Slim Healing Abutment 3.5mmD x 3mmL	Ti 6Al 4V ELI
	RP0048	RP Slim Healing Abutment 3.5mmD x 4mmL	Ti 6Al 4V ELI
	RP0049	RP Slim Healing Abutment 3.5mmD x 5mmL	Ti 6Al 4V ELI
	RP0050	RP Slim Healing Abutment 3.5mmD x 6mmL	Ti 6Al 4V ELI
	RP0022	RP Healing Abutment 4.5mmD x 2mmL	Ti 6Al 4V ELI
	RP0023	RP Healing Abutment 4.5mmD x 3mmL	Ti 6Al 4V ELI
	RP0024	RP Healing Abutment 4.5mmD x 4mmL	Ti 6Al 4V ELI
	RP0025	RP Healing Abutment 4.5mmD x 5mmL	Ti 6Al 4V ELI
	RP0026	RP Healing Abutment 4.5mmD x 6mmL	Ti 6Al 4V ELI
	RP0090	RP Conical Healing Abutment 4.5mmD x 2mmL	Ti 6Al 4V ELI
	RP0091	RP Conical Healing Abutment 4.5mmD x 3mmL	Ti 6Al 4V ELI
	RP0092	RP Conical Healing Abutment 4.5mmD x 4mmL	Ti 6Al 4V ELI
	RP0093	RP Conical Healing Abutment 4.5mmD x 5mmL	Ti 6Al 4V ELI
	RP0094	RP Conical Healing Abutment 4.5mmD x 6mmL	Ti 6Al 4V ELI

Cement Retained







	RP0020	RP Straight Slim Abutment - No End Line	Ti 6Al 4V ELI
	RP0012	RP Straight Abutment 1mm	Ti 6Al 4V ELI
	RP0011	RP Straight Abutment 2mm	Ti 6Al 4V ELI
	RP0010	RP Straight Abutment 3mm	Ti 6Al 4V ELI
	RP0013	RP Angled Abutment 15° 1mm	Ti 6Al 4V ELI
	RP0014	RP Angled Abutment 15° 2mm	Ti 6Al 4V ELI
	RP0015	RP Angled Abutment 15° 3mm	Ti 6Al 4V ELI
	RP0043	RP Engaging Temporary Abutment	Ti 6Al 4V ELI
	RP0044	RP Non Engaging Temporary Abutment	Ti 6Al 4V ELI
	RP0045	RP Engaging Plastic Cylinder Abutment	POM
	RP3095	RP Engaging Titanium / Plastic Abutment	Ti 6Al 4V ELI/ POM
	RP3097	RP Non-Engaging Titanium / Plastic Abutment	Ti 6Al 4V ELI/ POM

Screw Retained - MU Trans Mucosal Abutments (TMA™)

	RP0032	RP Straight Trans Mucosal Abutment 1mm	Ti 6Al 4V ELI
	RP0033	RP Straight Trans Mucosal Abutment 2mm	Ti 6Al 4V ELI
	RP0034	RP Straight Trans Mucosal Abutment 3mm	Ti 6Al 4V ELI
	RP3729	RP Straight Trans Mucosal Abutment 4mm	Ti 6Al 4V ELI
	RP3730	RP Straight Trans Mucosal Abutment 5mm	Ti 6Al 4V ELI
	RP3734	RP Angled Trans Mucosal Abutment 17° 2.5mm	Ti 6Al 4V ELI
	RP3737	RP Angled Trans Mucosal Abutment 17° 3.5mm	Ti 6Al 4V ELI
	RP3735	RP Angled Trans Mucosal Abutment 30° 3mm	Ti 6Al 4V ELI
	RP3738	RP Angled Trans Mucosal Abutment 30° 4mm	Ti 6Al 4V ELI
	RS5005	TMA Healing Cap	Ti 6Al 4V ELI
	RS4900	TMA Titanium Temporary Cylinder	Ti 6Al 4V ELI
	RS5001	TMA Plastic Casting Sleeve w / Prosthetic Screw	POM
	RS5004	TMA Abutment Replica	Ti 6Al 4V ELI
	RS5006	TMA Open Tray Transfer	Ti 6Al 4V ELI
	RS5011	TMA Closed Tray Transfer	Ti 6Al 4V ELI

* The term "impression coping" has been amended to the term "transfer" (the terms are synonymous). Please note that either term may appear in different documentation.



Screw Retained - Flat Connection

	RP0030	RP Flat Connection Abutment 2mm	Ti 6Al 4V ELI
	RP0031	RP Flat Connection Abutment 4mm	Ti 6Al 4V ELI
	FC5515	Flat Connection Temporary Cylinder Sleeve	Ti 6Al 4V ELI
	FC5737	Flat Connection Implant Replica	Stainless Steel
	FC6011	Flat Connection Castable Abutment for Centring Ring	POM
	FC6015	Flat Connection Titanium Retaining Screw	Ti 6Al 4V ELI
	FC6013	Flat Connection Titanium Gluing Ring	Ti 6Al 4V ELI
	FC6017	Flat Connection Long Laboratory Screw	Ti 6Al 4V ELI
	FC6018	Flat Connection Centering Ring	Ti 6Al 4V ELI
	FC5512	Flat Connection Transfer	Ti 6Al 4V ELI









Ball Attachment - Overdentures

	RP0051	RP Ball Attachment 0.5mm	Ti 6Al 4V ELI
	RP0052	RP Ball Attachment 1mm	Ti 6Al 4V ELI
	RP0053	RP Ball Attachment 2mm	Ti 6Al 4V ELI
	RP0054	RP Ball Attachment 3mm	Ti 6Al 4V ELI
	RP0055	RP Ball Attachment 4mm	Ti 6Al 4V ELI
	RP0056	RP Ball Attachment 5mm	Ti 6Al 4V ELI
	RS2660	Plastic Ball Cap White	Nylon
	RS2662	Plastic Ball Cap Pink Soft	Nylon
	RS2670	Titanium Ball Cap	Ti 6Al 4V ELI
	RS2675SS	Stainless Steel Ball Cap	Stainless Steel

Analogs

	RP0007	RP Implant Analog	Stainless Steel
	RS5740	Ball Attachment Abutment Replica	Stainless Steel

Transfers / Impression Coping

	RP5109	RP Slim Closed Tray Transfer 3.6mmDx9mmL	Ti 6Al 4V ELI
	RP5113	RP Slim Closed Tray Transfer 3.6mmDx13mmL	Ti 6Al 4V ELI
	RP5209	RP Closed Tray Transfer 4.2mmDx9mmL	Ti 6Al 4V ELI
	RP5213	RP Closed Tray Transfer 4.2mmDx13mmL	Ti 6Al 4V ELI
	RP5610	RP Slim Open Tray Transfer 3.6mmDx10mmL	Ti 6Al 4V ELI
	RP5614	RP Slim Open Tray Transfer 3.6mmDx14mmL	Ti 6Al 4V ELI
	RP5510	RP Open Tray Transfer 4.2mmDx10mmL	Ti 6Al 4V ELI
	RP5514	RP Open Tray Transfer 4.2mmDx14mmL	Ti 6Al 4V ELI













* Transfers can be tightened by Star Driver.

* Transfers will be chosen by length and width according to the planned prosthetic treatment and according to the interocclusal distance.

RP Retrieval Screw





	RP3401	RP Retrieval Screw for Abutments	Ti 6Al 4V ELI
---	--------	----------------------------------	---------------

RP Screws

	RP0073	RP Conical Implant Cover Screw	Ti 6Al 4V ELI
	RP0001	RP Abutment Screw	Ti 6Al 4V ELI
	RP0039	RP Retaining Screw for TMA 1mm	Ti 6Al 4V ELI
	RP0040	RP Retaining Screw for TMA 2mm	Ti 6Al 4V ELI
	RP0041	RP Retaining Screw for TMA 3mm	Ti 6Al 4V ELI
	RP3409	RP Retaining Screw for TMA 4mm	Ti 6Al 4V ELI
	RP3412	RP Retaining Screw for TMA 5mm	Ti 6Al 4V ELI
	RP3403	RP Retaining Screw for Angled TMA	Ti 6Al 4V ELI
	RP5010	RP Open Tray Transfer Screw - Short	Ti 6Al 4V ELI
	RP5014	RP Open Tray Transfer Screw - Long	Ti 6Al 4V ELI
	RP5126	RP Closed Tray Transfer Screw - Short	Ti 6Al 4V ELI
	RP5127	RP Closed Tray Transfer Screw - Long	Ti 6Al 4V ELI

* All systems are provided with their compatible screws. However, they may also be ordered individually.

Hand Drivers

	RP0064	Star Hand Driver - Short	Stainless Steel
	RP0004	Star Hand Driver - Long	Stainless Steel
	RS6193	TMA/FC Female Hand Hex Driver - Short	Stainless Steel
	RS6191	TMA/FC Female Hand Hex Driver - Long	Stainless Steel

Torque Drivers

	RP0067	RP 2.2mm Hex Torque Driver - Short	Stainless Steel
	RP0066	RP 2.2mm Hex Torque Driver - Long	Stainless Steel
	RP0065	Star Torque Driver - Short	Stainless Steel
	RP0005	Star Torque Driver - Long	Stainless Steel
	RS6090	Torque Driver for Ball Attachment	Stainless Steel
	RS6197	TMA/FC Hex Torque Driver - Short	Stainless Steel
	RS6196	TMA/FC Hex Torque Driver - Long	Stainless Steel
	RA0050	Wrench Ratchet Surgical Instruments Handle * use with RP0068/ RP0071/ RP0074	Stainless Steel

Handpiece Drivers and Adaptors

	RP0068	RP 2.25mm Hex Handpiece Adapter - Short	Stainless Steel
	RP0071	RP 2.25mm Hex Handpiece Adapter - Medium	Stainless Steel
	RP0074	RP 2.25mm Hex Handpiece Adapter - Long	Stainless Steel
	RP0018	Star Handpiece Driver - Short	Stainless Steel
	RP0019	Star Handpiece Driver - Long	Stainless Steel
	RP0062	RP Handpiece Hex Adapter - Short	Stainless Steel
	RP0072	RP Handpiece Hex Adapter - Long	Stainless Steel
	RS6194	TMA/FC Hex Handpiece Adapter - Short	Stainless Steel
	RS6195A	TMA/FC Hex Handpiece Adapter - Long	Stainless Steel

WP CloseFit™ Ø4.3

OsseoFix™ Surface
Titanium Alloy - Ti 6Al 4V ELI

Catalog No.	Length mm		
ISPX0843	8		
ISPX1043	10		
ISPX1143	11.5		
ISPX1343	13		
ISPX1543	15		
ISPX1843	18		

Drill Sequence

BONE TYPE D-IV	BONE TYPE D-II & III	BONE TYPE D-I
1. Tri-Step* 2. (3.6)	1. Tri-Step* 2. (3.6)	1. Tri-Step* 2. 3.6

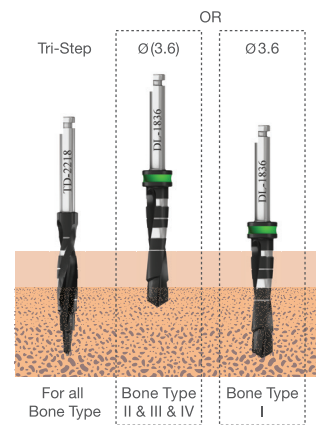

Note: (x.xx) drill to the depth of the cortex only. All measurements are in mm.

⚠ CAUTION: The drill preparation is up to 1mm longer than the implant.

* For initial drilling, you may use 2, 2.8 and 3.2 drills in sequence instead of the Tri-Step drill.

Radiographic Template

WP CloseFit™ Ø5.0

OsseoFix™ Surface
Titanium Alloy - Ti 6Al 4V ELI

Catalog No.	Length mm	
ISPX0849	8	
ISPX1049	10	
ISPX1149	11.5	
ISPX1349	13	
ISPX1549	15	
ISPX1849	18	

Drill Sequence

BONE TYPE D-IV	BONE TYPE D-II & III	BONE TYPE D-I
1. Tri-Step*	1. Tri-Step*	1. Tri-Step*
2. 3.6	2. 3.6	2. 3.6
3. (4.2)	3. 4.2	3. 4.2
	4. (4.6)	4. 4.6

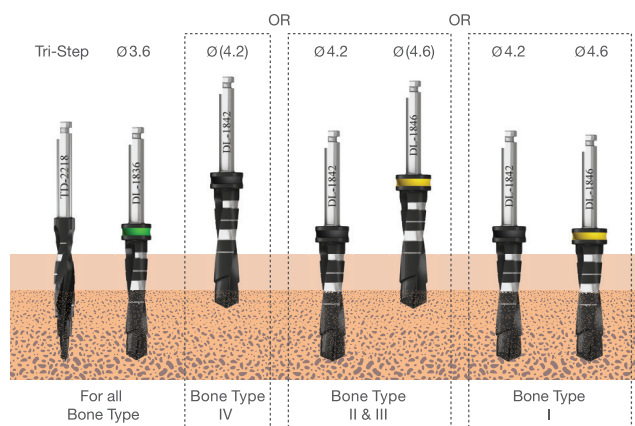

Note: (x.xx) drill to the depth of the cortex only.
All measurements are in mm.

⚠ CAUTION: The drill preparation is up to 1mm longer than the implant.

* For initial drilling, you may use 2, 2.8 and 3.2 drills in sequence instead of the Tri-Step drill.



Radiographic Template

ASD0612 | Radiographic Template RP/WP















Healing Abutments & Cover Screw

	WP0073	WP Conical Implant Cover Screw	Ti 6Al 4V ELI
	WP0046	WP Slim Healing Abutment 4mmD x 2mmL	Ti 6Al 4V ELI
	WP0047	WP Slim Healing Abutment 4mmD x 3mmL	Ti 6Al 4V ELI
	WP0048	WP Slim Healing Abutment 4mmD X 4mmL	Ti 6Al 4V ELI
	WP0049	WP Slim Healing Abutment 4mmD X 5mmL	Ti 6Al 4V ELI
	WP0050	WP Slim Healing Abutment 4mmD X 6mmL	Ti 6Al 4V ELI
	WP0022	WP Healing Abutment 5.5mmD X 2mmL	Ti 6Al 4V ELI
	WP0023	WP Healing Abutment 5.5mmD X 3mmL	Ti 6Al 4V ELI
	WP0024	WP Healing Abutment 5.5mmD X 4mmL	Ti 6Al 4V ELI
	WP0025	WP Healing Abutment 5.5mmD X 5mmL	Ti 6Al 4V ELI
	WP0026	WP Healing Abutment 5.5mmD X 6mmL	Ti 6Al 4V ELI
	WP0090	WP Conical Healing Abutment 5.5mmD x 2mmL	Ti 6Al 4V ELI
	WP0091	WP Conical Healing Abutment 5.5mmD x 3mmL	Ti 6Al 4V ELI
	WP0092	WP Conical Healing Abutment 5.5mmD x 4mmL	Ti 6Al 4V ELI
	WP0093	WP Conical Healing Abutment 5.5mmD x 5mmL	Ti 6Al 4V ELI
	WP0094	WP Conical Healing Abutment 5.5mmD x 6mmL	Ti 6Al 4V ELI

Cement Retained







	WP0020	WP Straight Slim Abutment - No End Line	Ti 6Al 4V ELI
	WP0012	WP Straight Abutment 1mm	Ti 6Al 4V ELI
	WP0011	WP Straight Abutment 2mm	Ti 6Al 4V ELI
	WP0010	WP Straight Abutment 3mm	Ti 6Al 4V ELI
	WP0013	WP Angled Abutment 15° 1mm	Ti 6Al 4V ELI
	WP0014	WP Angled Abutment 15° 2mm	Ti 6Al 4V ELI
	WP0015	WP Angled Abutment 15° 3mm	Ti 6Al 4V ELI
	WP0043	WP Engaging Temporary Abutment	Ti 6Al 4V ELI
	WP0044	WP Non Engaging Temporary Abutment	Ti 6Al 4V ELI
	WP0045	WP Engaging Plastic Cylinder Abutment	POM
	WP3095	WP Engaging Titanium / Plastic Abutment	Ti 6Al 4V ELI / POM
	WP3097	WP Non Engaging Titanium / Plastic Abutment	Ti 6Al 4V ELI / POM

Screw Retained - MU Trans Mucosal Abutments (TMA™)

	WP3731	WP Straight Trans Mucosal Abutment 1mm	Ti 6Al 4V ELI
	WP3732	WP Straight Trans Mucosal Abutment 2mm	Ti 6Al 4V ELI
	WP3733	WP Straight Trans Mucosal Abutment 3mm	Ti 6Al 4V ELI
	WP3729	WP Straight Trans Mucosal Abutment 4mm	Ti 6Al 4V ELI
	WP3730	WP Straight Trans Mucosal Abutment 5mm	Ti 6Al 4V ELI
	WP3734	WP Angled Trans Mucosal Abutment 17° 2.5mm	Ti 6Al 4V ELI
	WP3737	WP Angled Trans Mucosal Abutment 17° 3.5mm	Ti 6Al 4V ELI
	WP3735	WP Angled Trans Mucosal Abutment 30° 3mm	Ti 6Al 4V ELI
	WP3738	WP Angled Trans Mucosal Abutment 30° 4mm	Ti 6Al 4V ELI
	RS5005	TMA Healing Cap	Ti 6Al 4V ELI
	RS4900	TMA Titanium Temporary Cylinder	Ti 6Al 4V ELI
	RS5001	TMA Plastic Casting Sleeve w/Prosthetic Screw	POM
	RS5004	TMA Abutment Replica	Ti 6Al 4V ELI
	RS5006	TMA Open Tray Transfer	Ti 6Al 4V ELI
	RS5011	TMA Closed Tray Transfer	Ti 6Al 4V ELI

* The term "impression coping" has been amended to the term "transfer" (the terms are synonymous). Please note that either term may appear in different documentation.



Screw Retained - Flat Connection

	WP0030	WP Flat Connection Abutment 2mm	Ti 6Al 4V ELI
	WP0031	WP Flat Connection Abutment 4mm	Ti 6Al 4V ELI
	FC5515	Flat Connection Temporary Cylinder Sleeve	Ti 6Al 4V ELI
	FC5737	Flat Connection Implant Replica	Ti 6Al 4V ELI
	FC6011	Flat Connection Castable Abutment for Centring Ring	POM
	FC6015	Flat Connection Titanium Retaining Screw	Ti 6Al 4V ELI
	FC6013	Flat Connection Titanium Gluing Ring	Ti 6Al 4V ELI
	FC6017	Flat Connection Long Laboratory Screw	Ti 6Al 4V ELI
	FC6018	Flat Connection Centering Ring	Ti 6Al 4V ELI
	FC5512	Flat Connection Transfer	Ti 6Al 4V ELI













Ball Attachment - Overdentures

	WP0051	WP Ball Attachment 0.5mm	Ti 6Al 4V ELI
	WP0052	WP Ball Attachment 1mm	Ti 6Al 4V ELI
	WP0053	WP Ball Attachment 2mm	Ti 6Al 4V ELI
	WP0054	WP Ball Attachment 3mm	Ti 6Al 4V ELI
	WP0055	WP Ball Attachment 4mm	Ti 6Al 4V ELI
	WP0056	WP Ball Attachment 5mm	Ti 6Al 4V ELI
	RS2660	Plastic Ball Cap White	Nylon
	RS2662	Plastic Ball Cap Pink Soft	Nylon
	RS2670	Titanium Ball Cap	Ti 6Al 4V ELI
	RS2675SS	Stainless Steel Ball Cap	Stainless Steel

Analog

	WP0007	WP Implant Analog	Stainless Steel
	RS5740	Ball Attachment Abutment Replica	Stainless Steel

Transfers / Impression Coping

	WP5109	WP Slim Closed Tray Transfer 4mmDx9mmL	Ti 6Al 4V ELI
	WP5113	WP Slim Closed Tray Transfer 4mmDx13mmL	Ti 6Al 4V ELI
	WP5209	WP Closed Tray Transfer 5.2mmDx9mmL	Ti 6Al 4V ELI
	WP5213	WP Closed Tray Transfer 5.2mmDx13mmL	Ti 6Al 4V ELI
	WP5309	WP Wide Closed Tray Transfer 6mmDx9mmL	Ti 6Al 4V ELI
	WP5313	WP Wide Closed Tray Transfer 6mmDx13mmL	Ti 6Al 4V ELI
	WP5610	WP Slim Open Tray Transfer 4mmDx10mmL	Ti 6Al 4V ELI
	WP5614	WP Slim Open Tray Transfer 4mmDx14mmL	Ti 6Al 4V ELI
	WP5510	WP Open Tray Transfer 5.2mmDx10mmL	Ti 6Al 4V ELI
	WP5514	WP Open Tray Transfer 5.2mmDx14mmL	Ti 6Al 4V ELI
	WP5410	WP Wide Open Tray Transfer 6mmDx10mmL	Ti 6Al 4V ELI
	WP5414	WP Wide Open Tray Transfer 6mmDx14mmL	Ti 6Al 4V ELI

* Transfers can be tightened by Star Driver.

* Transfers will be chosen by length and width according to the planned prosthetic treatment and according to the interocclusal distance.

WP Retrieval Screw



WP3401

WP Retrieval Screw for Abutments

Ti 6Al 4V ELI

WP Screws



WP0073

WP Conical Implant Cover Screw

Ti 6Al 4V ELI



WP0001

WP Abutment Screw

Ti 6Al 4V ELI



WP3406

WP Retaining Screw for TMA 1mm

Ti 6Al 4V ELI



WP3407

WP Retaining Screw for TMA 2mm

Ti 6Al 4V ELI



WP3408

WP Retaining Screw for TMA 3mm

Ti 6Al 4V ELI



WP3409

WP Retaining Screw for TMA 4mm

Ti 6Al 4V ELI



WP3412

WP Retaining Screw for TMA 5mm

Ti 6Al 4V ELI



WP3403

WP Retaining Screw for Angled TMA

Ti 6Al 4V ELI



WP5010

WP Open Tray Transfer Screw - Short

Ti 6Al 4V ELI



WP5014

WP Open Tray Transfer Screw - Long

Ti 6Al 4V ELI



WP5126

WP Closed Tray Transfer Screw - Short

Ti 6Al 4V ELI







WP5127

WP Closed Tray Transfer Screw - Long

Ti 6Al 4V ELI

* All systems are provided with their compatible screws. However, they may also be ordered individually.

Hand Drivers

	RP0064	Star Hand Driver - Short	Stainless Steel
	RP0004	Star Hand Driver - Long	Stainless Steel
	RS6193	TMA / FC Female Hand Hex Driver - Short	Stainless Steel
	RS6191	TMA / FC Female Hand Hex Driver - Long	Stainless Steel

Torque Drivers

	WP0067	WP 2.6mm Torque Driver - Short	Stainless Steel
	WP0066	WP 2.6mm Torque Driver - Long	Stainless Steel
	RP0065	Star Torque Driver - Short	Stainless Steel
	RP0005	Star Torque Driver - Long	Stainless Steel
	RS6090	Torque Driver for Ball Attachment	Stainless Steel
	RS6197	TMA / FC Hex Torque Driver - Short	Stainless Steel
	RS6196	TMA / FC Hex Torque Driver - Long	Stainless Steel
	RA0050	Wrench Ratchet Surgical Instruments Handle * use with WP0068/ WP0071/ WP0074	Stainless Steel

Handpiece Drivers and Adaptors

	WP0068	WP 2.65mm Hex Handpiece Adapter - Short	Stainless Steel
	WP0071	WP 2.65mm Hex Handpiece Adapter - Medium	Stainless Steel
	WP0074	WP 2.65mm Hex Handpiece Adapter - Long	Stainless Steel
	RP0018	Star Handpiece Driver - Short	Stainless Steel
	RP0019	Star Handpiece Driver - Long	Stainless Steel
	WP0062	WP Handpiece Hex Adapter - Short	Stainless Steel
	WP0072	WP Handpiece Hex Adapter - Long	Stainless Steel
	RS6194	TMA / FC Hex Handpiece Adapter - Short	Stainless Steel
	RS6195A	TMA / FC Hex Handpiece Adapter - Long	Stainless Steel

Reliable

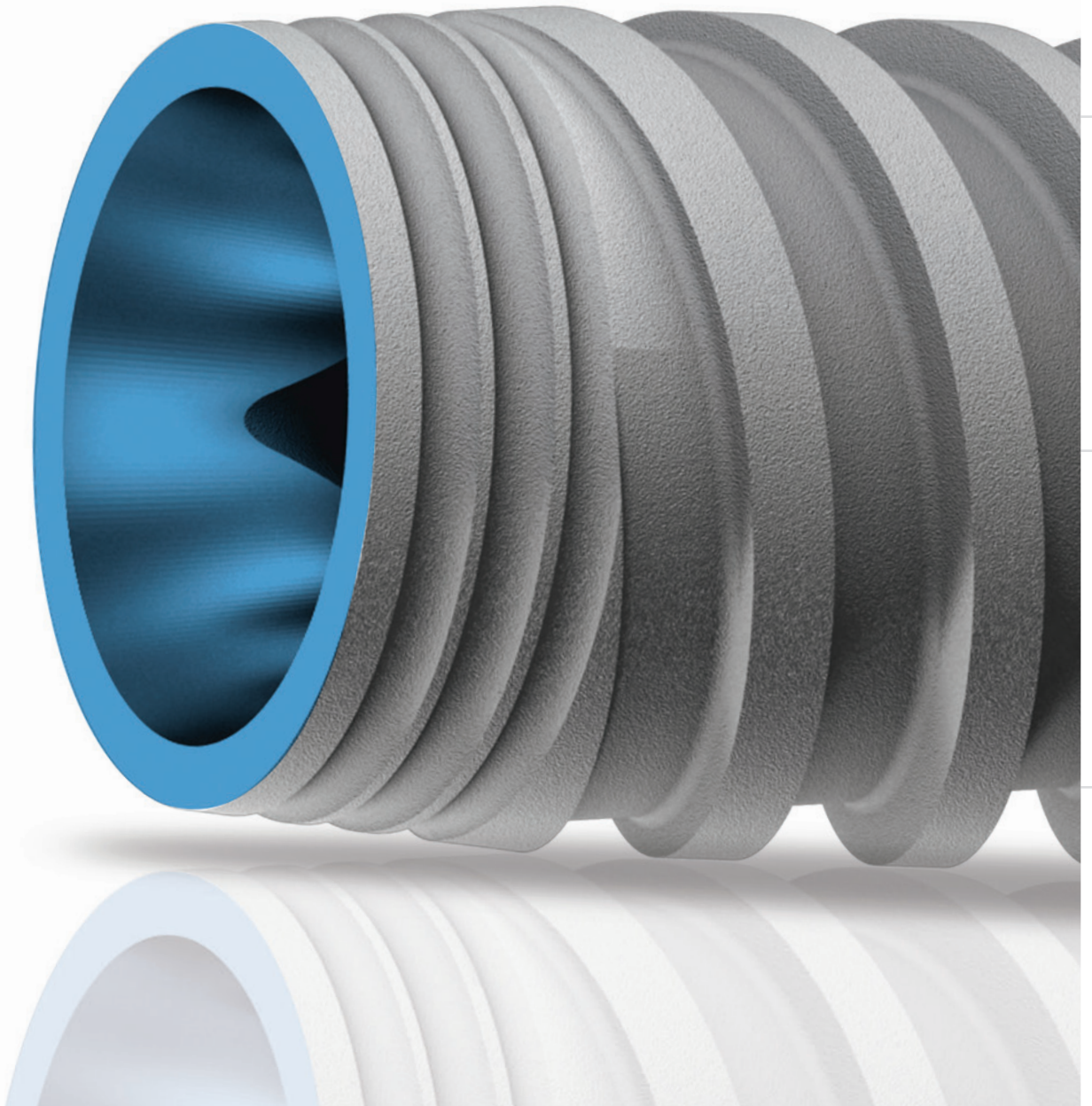

Touareg™ os|s

Touareg™-OS

Osseofix™ Surface Treatment

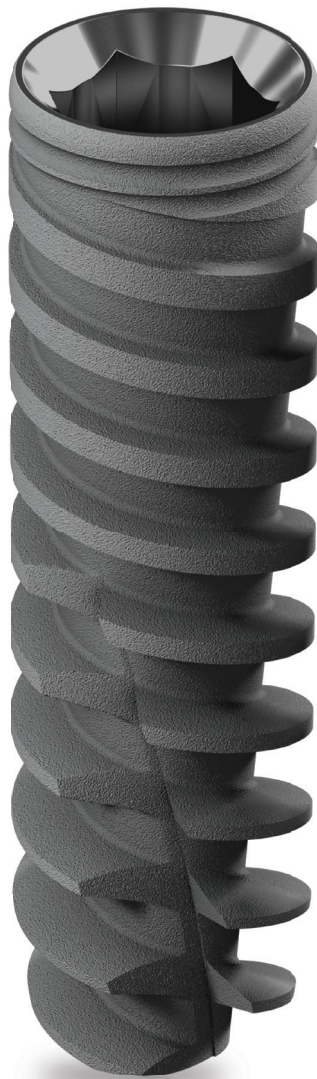

Touareg™-S

AB/AE Surface Treatment

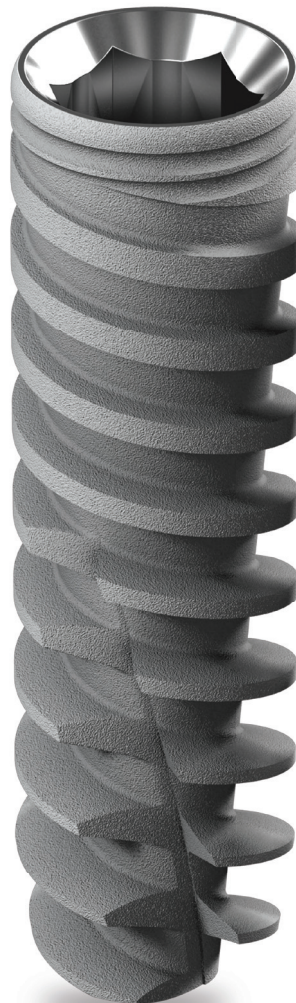

Standard Internal Hex Touareg™-OS and Touareg™-S

The Touareg™-OS, and Touareg™-S spiral implants are tapered implants with a spiral tap that condenses bone during placement for enhanced immediate stability. They have two large variable threads and a tapered core for accurate implant placement, self-tapping, improved esthetics and better load distribution.

The Touareg™-OS and Touareg™-S implants both feature a special round shaped apex that pushes the bone graft with minimal harm to anatomic structures. The Touareg™-S and Touareg™-OS implants are very user-friendly and their unique design often allows for immediate function for all bone types.

The Touareg™-S features a standard SLA™* - AB/AE- Alumina Oxide Blasted/Acid Etched surface treatment.

The Touareg™-OS features ADIN's unique OsseoFix™-Calcium Phosphate blast surface treatment.

* Institut Straumann AG's trademark

Touareg™-OS and Touareg™-S Advantages:

- Double Lead Threads (2X1.2mm)
- High Primary Stability, also in Type IV Bone
- Bone-Condensing Property
- Self-Tapping
- Redirecting Capability for Optimal Placement
- Built-In Platform Switching
- Minimally Invasive Surgery
- Immediate Function / Loading Capability
- Single Prosthetic Platform for Easy Restoration

Touareg™-OS

	L-6.25mm	L-8mm	L-10mm	L-11.5mm	L-13mm	L-16mm	L-18mm
ISF-Ø3.5mm		ISF0835	ISF1035	ISF1135	ISF1335	ISF1635	ISF1835
ISF-Ø3.75mm		ISF0838	ISF1038	ISF1138	ISF1338	ISF1638	ISF1838
ISF-Ø4.2mm	ISF0642	ISF0842	ISF1042	ISF1142	ISF1342	ISF1642	ISF1842
ISF-Ø5.0mm	ISF0650	ISF0850	ISF1050	ISF1150	ISF1350	ISF1650	
ISF-Ø6.0mm	ISF0660	ISF0860	ISF1060	ISF1160	ISF1360		

Touareg™-S

	L-6.25mm	L-8mm	L-10mm	L-11.5mm	L-13mm	L-16mm	L-18mm
ISPS-Ø3.5mm		ISPS 0835	ISPS1035	ISPS1135	ISPS1335	ISPS1635	ISPS1835
ISPS-Ø3.75mm		ISPS0838	ISPS1038	ISPS1138	ISPS1338	ISPS1638	ISPS1838
ISPS-Ø4.2mm	ISPS0642	ISPS0842	ISPS1042	ISPS1142	ISPS1342	ISPS1642	ISPS1842
ISPS-Ø5.0mm	ISPS0650	ISPS0850	ISPS1050	ISPS1150	ISPS1350	ISPS1650	
ISPS-Ø6.0mm	ISPS0660	ISPS0860	ISPS1060	ISPS1160	ISPS1360		

Touareg™ - OS Ø3.5

OsseoFix™ Surface
Titanium Alloy - Ti 6Al 4V ELI

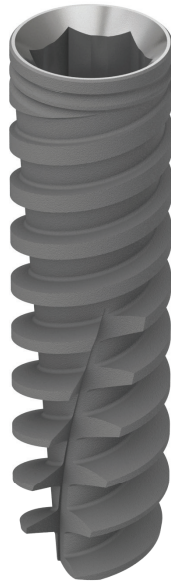
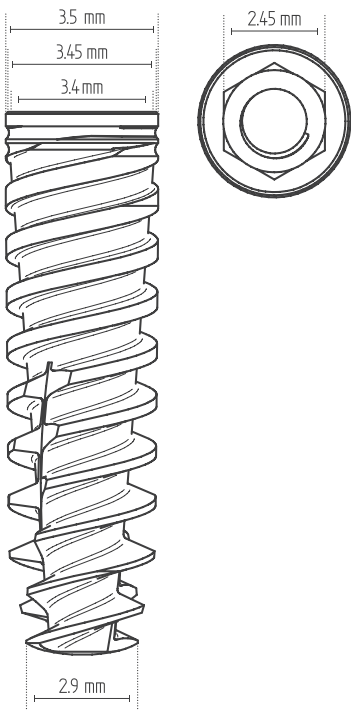
Catalog No.	Length mm		
ISF0835	8		
ISF1035	10		
ISF1135	11.5		
ISF1335	13		
ISF1635	16		
ISF1835	18		

Drill Sequence

BONE TYPE D-IV	BONE TYPE D-II & III	BONE TYPE D-I
1. Tri-Step*	1. Tri-Step* 2. (3.2)	1. Tri-Step* 2. (3.2)

Note: (x.xx) drill to the depth of the cortex only. All measurements are in mm.

⚠ CAUTION: The drill preparation is up to 1mm longer than the implant.

* For initial drilling, you may use 2, 2.8 and 3.2 drills in sequence instead of the Tri-Step drill.

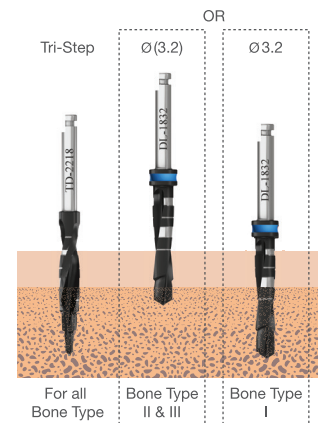

Radiographic Template

Touareg™ - OS $\varnothing 3.75$

OsseoFix™ Surface
Titanium Alloy - Ti 6Al 4V ELI

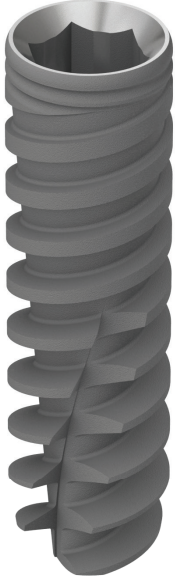
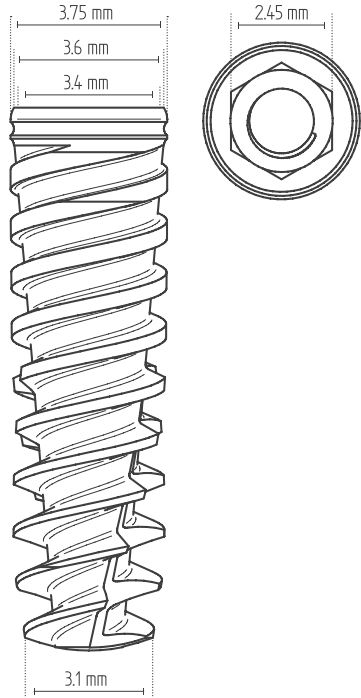
Catalog No.	Length mm		
ISF0838	8		
ISF1038	10		
ISF1138	11.5		
ISF1338	13		
ISF1638	16		
ISF1838	18		

Drill Sequence

BONE TYPE D-IV	BONE TYPE D-II & III	BONE TYPE D-I
1. Tri-Step*	1. Tri-Step* 2. (3.2)	1. Tri-Step* 2. 3.2

Note: (x.xx) drill to the depth of the cortex only. All measurements are in mm.

⚠ CAUTION: The drill preparation is up to 1mm longer than the implant.

* For initial drilling, you may use 2, 2.8 and 3.2 drills in sequence instead of the Tri-Step drill.

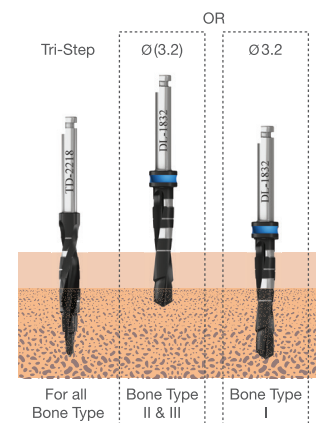

Radiographic Template

ASD0610 | Radiographic Template Touareg™ S/OS

Touareg™ - 05 Ø4.2

OsseoFix™ Surface
Titanium Alloy - Ti 6Al 4V ELI

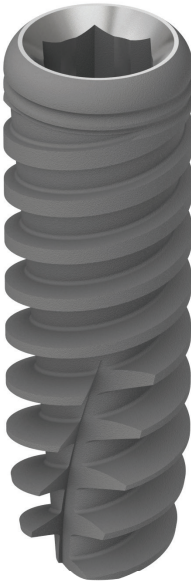
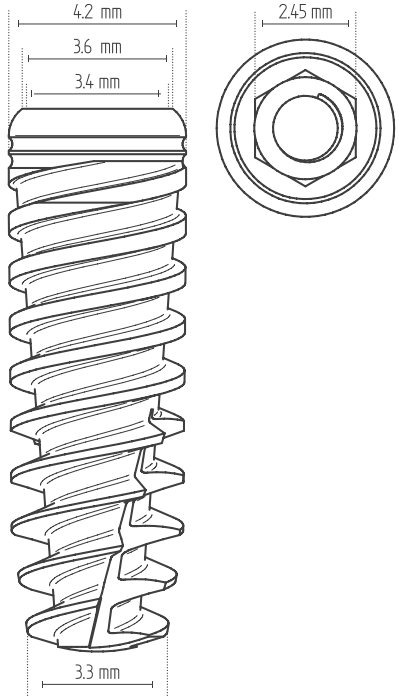
Catalog No.	Length mm		
ISF0642	6.25		
ISF0842	8		
ISF1042	10		
ISF1142	11.5		
ISF1342	13		
ISF1642	16		
ISF1842	18		

Drill Sequence

BONE TYPE D-IV	BONE TYPE D-II & III	BONE TYPE D-I
1. Tri-Step* 2. (3.6)	1. Tri-Step* 2. (3.6)	1. Tri-Step* 2. 3.6

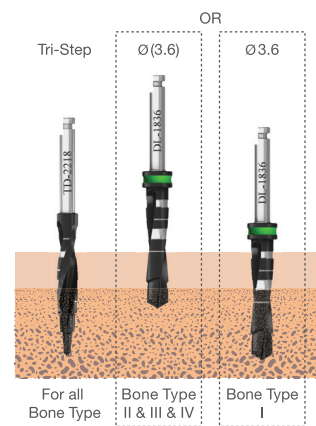

Note: (x.xx) drill to the depth of the cortex only. All measurements are in mm.

⚠ CAUTION: The drill preparation is up to 1mm longer than the implant.

* For initial drilling, you may use 2, 2.8 and 3.2 drills in sequence instead of the Tri-Step drill.

Radiographic Template

Touareg™ - OS Ø5.0

OsseoFix™ Surface
Titanium Alloy - Ti 6Al 4V ELI

Catalog No.	Length mm
ISF0650	6.25
ISF0850	8
ISF1050	10
ISF1150	11.5
ISF1350	13
ISF1650	16

Drill Sequence

BONE TYPE D-IV	BONE TYPE D-II & III	BONE TYPE D-I
1. Tri-Step*	1. Tri-Step*	1. Tri-Step*
2. 3.6	2. 3.6	2. 3.6
3. (4.2)	3. 4.2	3. 4.2
	4. (4.6)	4. 4.6

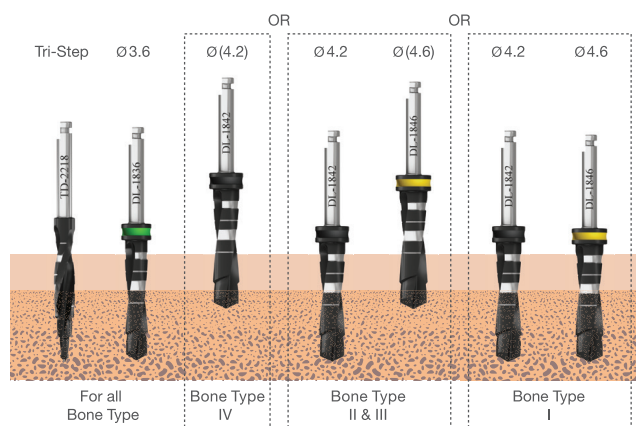

Note: (x.xx) drill to the depth of the cortex only.
All measurements are in mm.

- ⚠ CAUTION: The drill preparation is up to 1mm longer than the implant.
* For initial drilling, you may use 2, 2.8 and 3.2 drills in sequence instead of the Tri-Step drill.

Radiographic Template

ASD0610 | Radiographic Template Touareg™ S/OS

Touareg™ - OS Ø6.0

OsseoFix™ Surface
Titanium Alloy - Ti 6Al 4V ELI

Catalog No.	Length mm	
ISF0660	6.25	
ISF0860	8	
ISF1060	10	
ISF1160	11.5	
ISF1360	13	

Drill Sequence

BONE TYPE D-IV	BONE TYPE D-II & III	BONE TYPE D-I
1. Tri-Step*	1. Tri-Step*	1. Tri-Step*
2. 3.6	2. 3.6	2. 3.6
3. 4.2	3. 4.2	3. 4.2
4. (5.2)	4. 5.2	4. 5.2
	5. (5.6)	5. 5.6

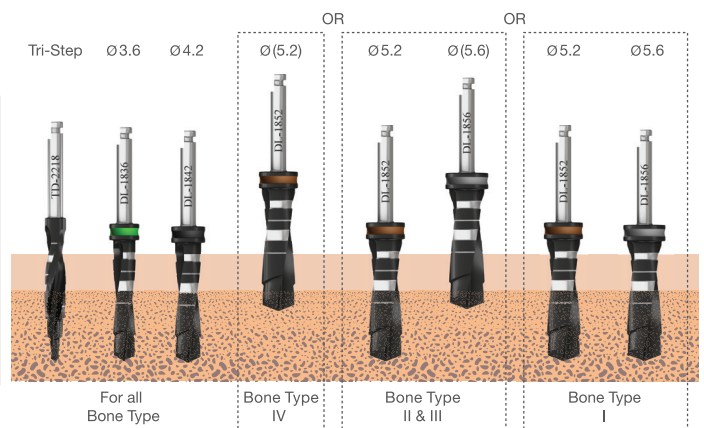

Note: (x.xx) drill to the depth of the cortex only.
All measurements are in mm.

⚠ CAUTION: The drill preparation is up to 1mm longer than the implant.

* For initial drilling, you may use 2, 2.8 and 3.2 drills in sequence instead of the Tri-Step drill.

Radiographic Template

Touareg™ - S Ø3.5

AB/AE Surface
Titanium Alloy - Ti 6Al 4V ELI

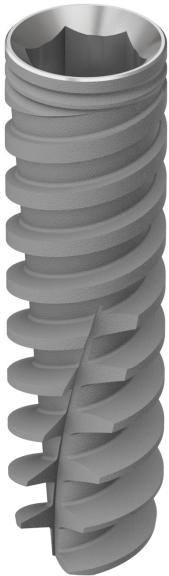
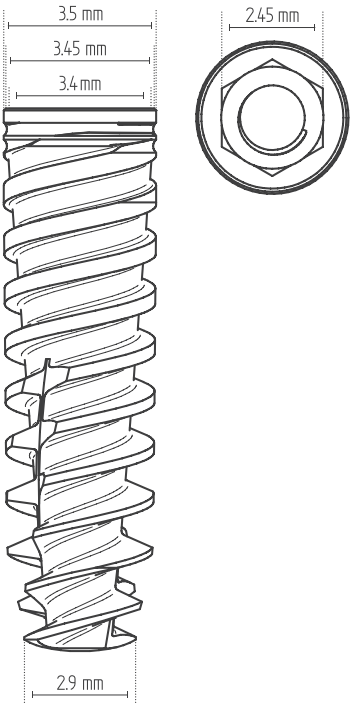
Catalog No.	Length mm		
ISPS0835	8		
ISPS1035	10		
ISPS1135	11.5		
ISPS1335	13		
ISPS1635	16		
ISPS1835	18		

Drill Sequence

BONE TYPE D-IV	BONE TYPE D-II & III	BONE TYPE D-I
1. Tri-Step*	1. Tri-Step* 2. (3.2)	1. Tri-Step* 2. (3.2)

Note: (x.xx) drill to the depth of the cortex only. All measurements are in mm.

⚠ CAUTION: The drill preparation is up to 1mm longer than the implant.

* For initial drilling, you may use 2, 2.8 and 3.2 drills in sequence instead of the Tri-Step drill.

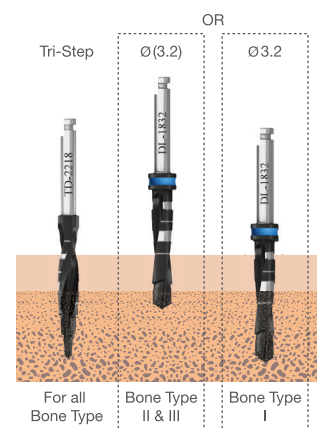

Radiographic Template

ASD0610 | Radiographic Template Touareg™ S/OS

Touareg™ - S Ø3.75

AB/AE Surface
Titanium Alloy - Ti 6Al 4V ELI

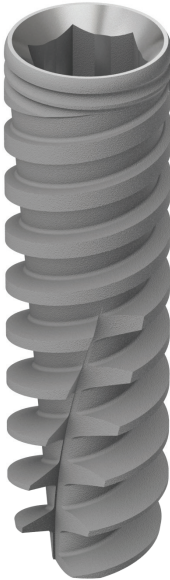
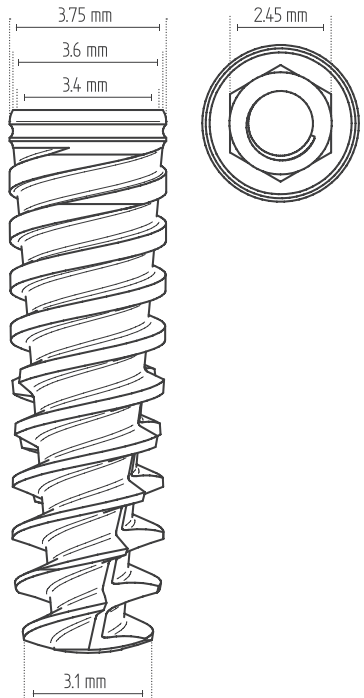
Catalog No.	Length mm		
ISPS0838	8		
ISPS1038	10		
ISPS1138	11.5		
ISPS1338	13		
ISPS1638	16		
ISPS1838	18		

Drill Sequence

BONE TYPE D-IV	BONE TYPE D-II & III	BONE TYPE D-I
1. Tri-Step*	1. Tri-Step* 2. (3.2)	1. Tri-Step* 2. 3.2

Note: (x.xx) drill to the depth of the cortex only. All measurements are in mm.

⚠ CAUTION: The drill preparation is up to 1mm longer than the implant.

* For initial drilling, you may use 2, 2.8 and 3.2 drills in sequence instead of the Tri-Step drill.

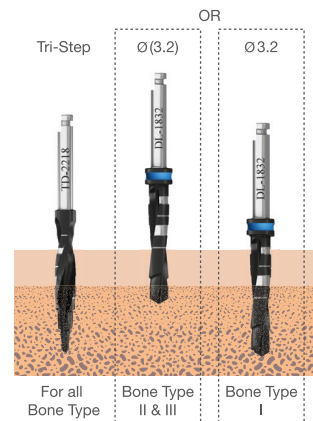

Radiographic Template

Touareg™ - S Ø4.2

AB/AE Surface
Titanium Alloy - Ti 6Al 4V ELI

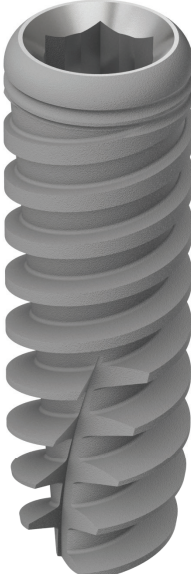
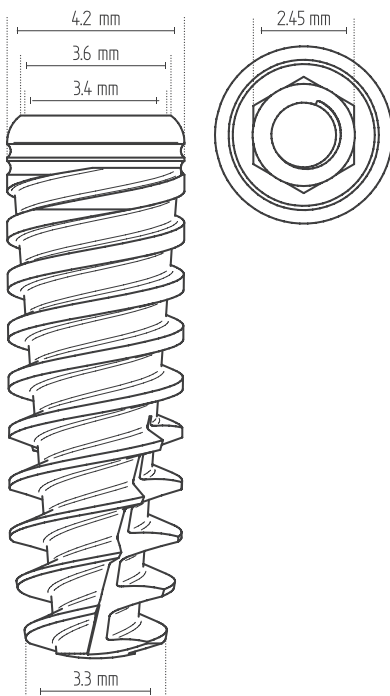
Catalog No.	Length mm		
ISPS0642	6.25		
ISPS0842	8		
ISPS1042	10		
ISPS1142	11.5		
ISPS1342	13		
ISPS1642	16		
ISPS1842	18		

Drill Sequence

BONE TYPE D-IV	BONE TYPE D-II & III	BONE TYPE D-I
1. Tri-Step* 2. (3.6)	1. Tri-Step* 2. (3.6)	1. Tri-Step* 2. 3.6

Note: (x.xx) drill to the depth of the cortex only. All measurements are in mm.

⚠ CAUTION: The drill preparation is up to 1mm longer than the implant.

* For initial drilling, you may use 2, 2.8 and 3.2 drills in sequence instead of the Tri-Step drill.

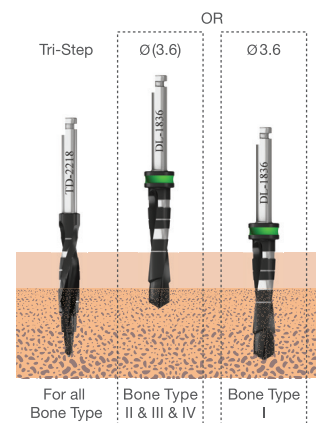

Radiographic Template

ASD0610 | Radiographic Template Touareg™ S/OS

Touareg™ - S Ø5.0

AB/AE Surface
Titanium Alloy - Ti 6Al 4V ELI

Catalog No.	Length mm	
ISPS0650	6.25	
ISPS0850	8	
ISPS1050	10	
ISPS1150	11.5	
ISPS1350	13	
ISPS1650	16	

Drill Sequence

BONE TYPE D-IV	BONE TYPE D-II & III	BONE TYPE D-I
1. Tri-Step*	1. Tri-Step*	1. Tri-Step*
2. 3.6	2. 3.6	2. 3.6
3. (4.2)	3. 4.2	3. 4.2
	4. (4.6)	4. 4.6

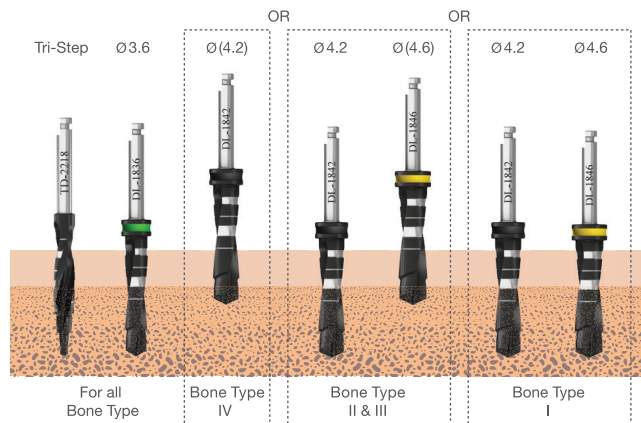

Note: (x.xx) drill to the depth of the cortex only.
All measurements are in mm.

⚠ CAUTION: The drill preparation is up to 1mm longer than the implant.

* For initial drilling, you may use 2, 2.8 and 3.2 drills in sequence instead of the Tri-Step drill.

Radiographic Template

Touareg™ - S Ø6.0

AB/AE Surface
Titanium Alloy - Ti 6Al 4V ELI

Catalog No.	Length mm	
ISPS0660	6.25	
ISPS0860	8	
ISPS1060	10	
ISPS1160	11.5	
ISPS1360	13	

Drill Sequence

BONE TYPE D-IV	BONE TYPE D-II & III	BONE TYPE D-I
1. Tri-Step*	1. Tri-Step*	1. Tri-Step*
2. 3.6	2. 3.6	2. 3.6
3. 4.2	3. 4.2	3. 4.2
4. (5.2)	4. 5.2	4. 5.2
	5. (5.6)	5. 5.6

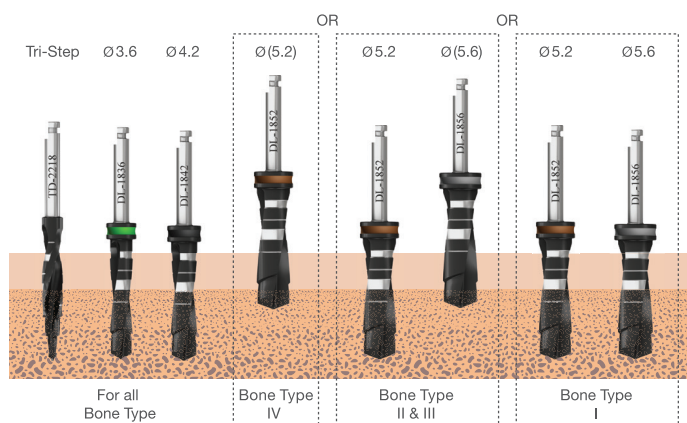

Note: (x.xx) drill to the depth of the cortex only.
All measurements are in mm.

⚠ CAUTION: The drill preparation is up to 1mm longer than the implant.

* For initial drilling, you may use 2, 2.8 and 3.2 drills in sequence instead of the Tri-Step drill.

Radiographic Template

ASD0610 | Radiographic Template Touareg™ S/OS

Swell™

SWELL™

AB/AE Surface Treatment

Swell™ Straight Implant System

The Swell™ is a straight, parallel walled, slightly tapered implant with V-shaped thread design.

Its unique design allows for accurate positioning, improved esthetics and better load distribution.

The Swell™ implant features the standard SLA™* - AB/AE - Alumina Oxide Blasted/Acid Etched surface treatment.

* Institut Straumann AG's trademark

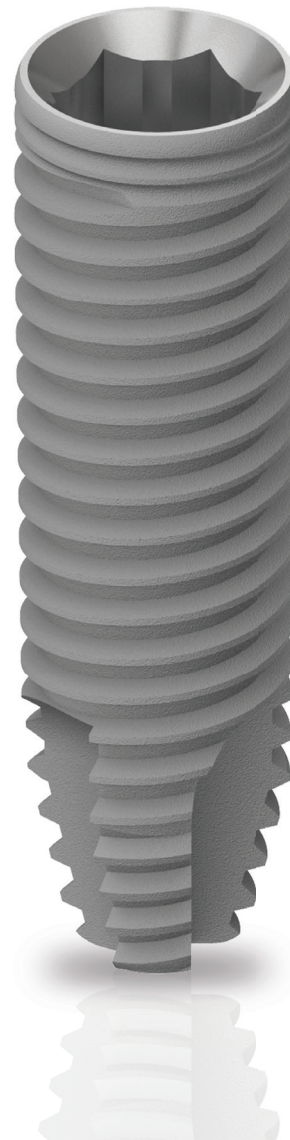

L-6.25mm L-8mm L-10mm L-11.5mm L-13mm L-16mm L-18mm

ID-Ø3.3mm		ID1033	ID1133	ID1333	ID1633	ID1833
ID-Ø3.75mm		ID0838	ID1038	ID1138	ID1338	ID1638
ID-Ø4.2mm	ID0642	ID0842	ID1042	ID1142	ID1342	ID1642
ID-Ø5.0mm	ID0650	ID0850	ID1050	ID1150	ID1350	ID1650
ID-Ø6.0mm	ID0660	ID0860	ID1060	ID1160	ID1360	

Swell™ Ø3.3

AB/AE Surface
Titanium Alloy - Ti 6Al 4V ELI

Catalog No.	Length mm		
ID1033	10		
ID1133	11.5		
ID1333	13		
ID1633	16		
ID1833	18		

Drill Sequence

BONE TYPE D-IV	BONE TYPE D-II & III	BONE TYPE D-I
1. 2.0 2. (2.8)	1. 2.0 2. (2.8) 3. (3.2)	1. Tri-Step*

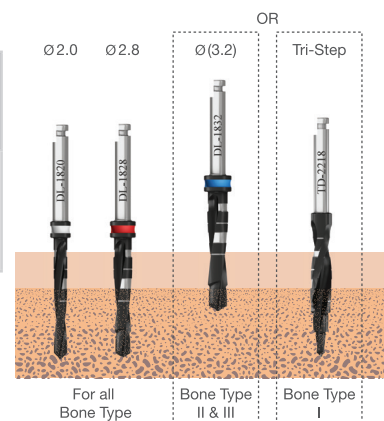

Note: (x.xx) drill to the depth of the cortex only.
All measurements are in mm.

⚠ CAUTION: The drill preparation is up to 1mm longer than the implant.

* For initial drilling, you may use 2, 2.8 and 3.2 drills in sequence instead of the Tri-Step drill.

Radiographic Template

ASD0613 | Radiographic Template Swell™

Swell™ Ø3.75

AB/AE Surface
Titanium Alloy - Ti 6Al 4V ELI

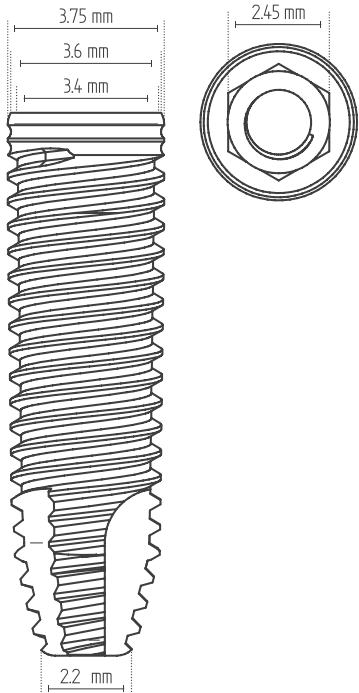
Catalog No.	Length mm		
ID0838	8		
ID1038	10		
ID1138	11.5		
ID1338	13		
ID1638	16		
ID1838	18		

Drill Sequence

BONE TYPE D-IV	BONE TYPE D-II & III	BONE TYPE D-I
1. Tri-Step*	1. Tri-Step* 2. (3.2)	1. Tri-Step* 2. 3.2

Note: (x.xx) drill to the depth of the cortex only. All measurements are in mm.

⚠ CAUTION: The drill preparation is up to 1mm longer than the implant.

* For initial drilling, you may use 2, 2.8 and 3.2 drills in sequence instead of the Tri-Step drill.

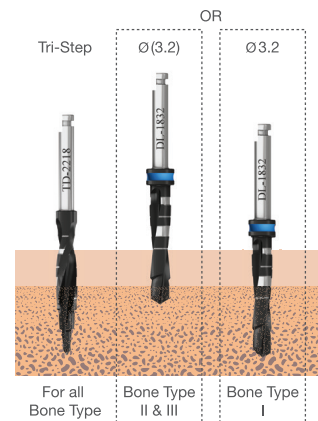

Radiographic Template

Swell™ Ø4.2

AB/AE Surface
Titanium Alloy - Ti 6Al 4V ELI

Catalog No.	Length mm	
ID0642	6.25	
ID0842	8	
ID1042	10	
ID1142	11.5	
ID1342	13	
ID1642	16	
ID1842	18	

Drill Sequence

BONE TYPE D-IV	BONE TYPE D-II & III	BONE TYPE D-I
1. Tri-Step* 2. 3.2	1. Tri-Step* 2. (3.6)	1. Tri-Step* 2. 3.6

Note: (x.xx) drill to the depth of the cortex only.
All measurements are in mm.

⚠ CAUTION: The drill preparation is up to 1mm longer than the implant.
* For initial drilling, you may use 2, 2.8 and 3.2 drills in sequence instead of the Tri-Step drill.

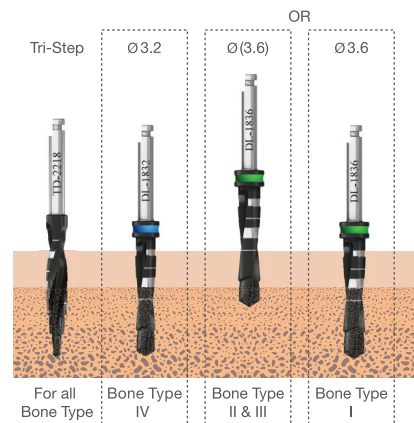

Radiographic Template

ASD0613 | Radiographic Template Swell™

Swell™ Ø5.0

AB/AE Surface
Titanium Alloy - Ti 6Al 4V ELI

Catalog No.	Length mm
ID0650	6.25
ID0850	8
ID1050	10
ID1150	11.5
ID1350	13
ID1650	16

Drill Sequence

BONE TYPE D-IV	BONE TYPE D-II & III	BONE TYPE D-I
1. Tri-Step*	1. Tri-Step*	1. Tri-Step*
2. 3.6	2. 3.6	2. 3.6
3. (4.2)	3. 4.2	3. 4.2
	4. (4.6)	4. 4.6

Note: (x.xx) drill to the depth of the cortex only.
All measurements are in mm.

⚠ CAUTION: The drill preparation is up to 1mm longer than the implant.
* For initial drilling, you may use 2, 2.8 and 3.2 drills in sequence instead of the Tri-Step drill.

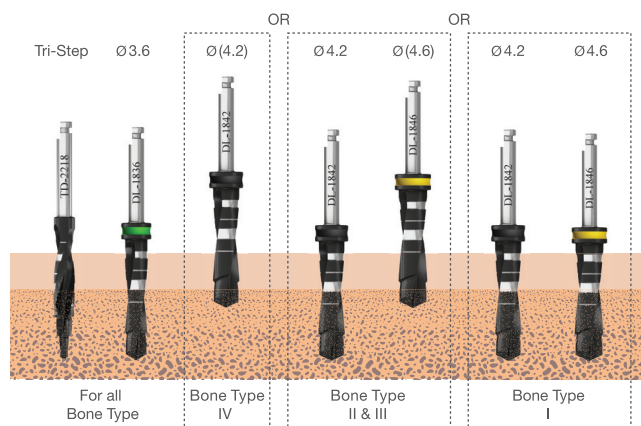

Radiographic Template

Swell™ Ø6.0

AB/AE Surface
Titanium Alloy - Ti 6Al 4V ELI

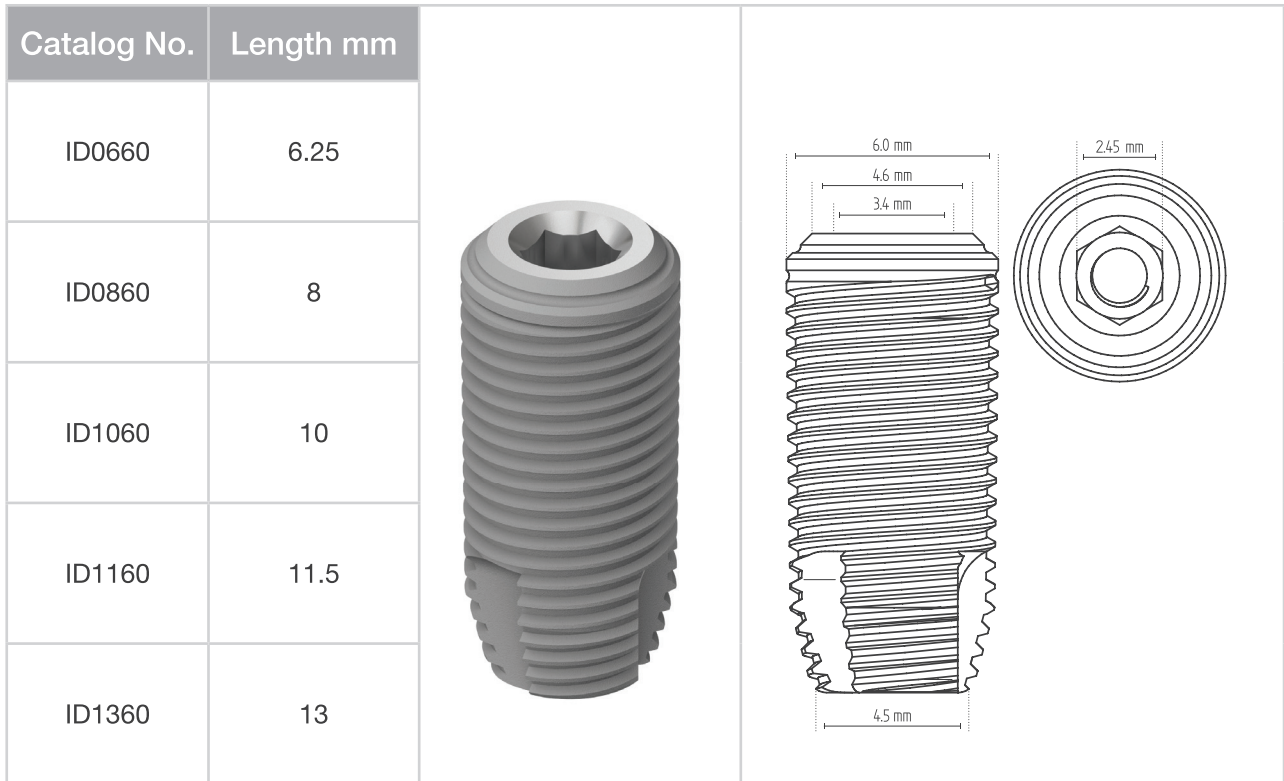

Drill Sequence

BONE TYPE D-IV	BONE TYPE D-II & III	BONE TYPE D-I
1. Tri-Step*	1. Tri-Step*	1. Tri-Step*
2. 3.6	2. 3.6	2. 3.6
3. 4.2	3. 4.2	3. 4.2
4. 4.6	4. 4.6	4. 4.6
5. (5.2)	5. 5.2	5. 5.2
	6. (5.6)	6. (5.6)

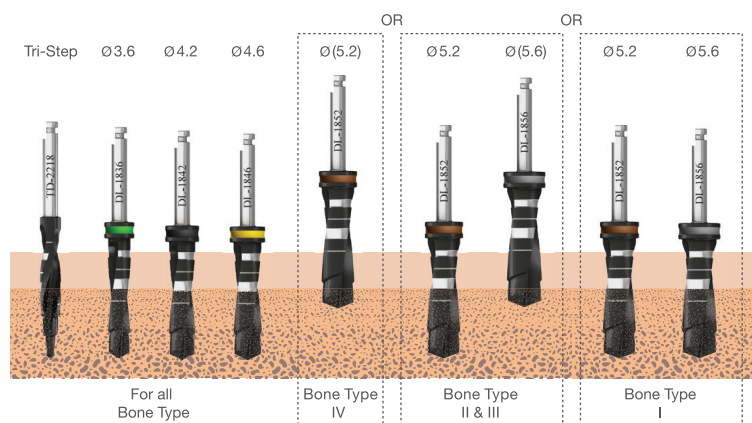

Note: (x.xx) drill to the depth of the cortex only.
All measurements are in mm.

⚠ CAUTION: The drill preparation is up to 1mm longer than the implant.

* For initial drilling, you may use 2, 2.8 and 3.2 drills in sequence instead of the Tri-Step drill.













Radiographic Template

ASD0613 | Radiographic Template Swell™



















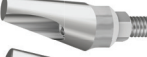



Healing Abutments & Cover Screw

	RS3435	RS Implant Cover Screw	Ti 6Al 4V ELI
	RS3027	RS Slim Healing Abutment 3.5mmD x 2mmL	Ti 6Al 4V ELI
	RS3028	RS Slim Healing Abutment 3.5mmD x 3mmL	Ti 6Al 4V ELI
	RS3029	RS Slim Healing Abutment 3.5mmD x 4mmL	Ti 6Al 4V ELI
	RS3030	RS Slim Healing Abutment 3.5mmD x 5mmL	Ti 6Al 4V ELI
	RS3031	RS Slim Healing Abutment 3.5mmD x 6mmL	Ti 6Al 4V ELI
	RS3022	RS Healing Abutment 4.5mmD x 2mmL	Ti 6Al 4V ELI
	RS3023	RS Healing Abutment 4.5mmD x 3mmL	Ti 6Al 4V ELI
	RS3024	RS Healing Abutment 4.5mmD x 4mmL	Ti 6Al 4V ELI
	RS3025	RS Healing Abutment 4.5mmD x 5mmL	Ti 6Al 4V ELI
	RS3026	RS Healing Abutment 4.5mmD x 6mmL	Ti 6Al 4V ELI
	RS3012	RS Wide Healing Abutment 6mmD x 2mmL	Ti 6Al 4V ELI
	RS3013	RS Wide Healing Abutment 6mmD x 3mmL	Ti 6Al 4V ELI
	RS3014	RS Wide Healing Abutment 6mmD x 4mmL	Ti 6Al 4V ELI
	RS3015	RS Wide Healing Abutment 6mmD x 5mmL	Ti 6Al 4V ELI



Cement Retained

	RS3903	RS Slim Titanium Abutment 3mm	Ti 6Al 4V ELI
	RS3906	RS Slim Titanium Abutment 6mm	Ti 6Al 4V ELI
	RS3908	RS Slim Titanium Abutment 8mm	Ti 6Al 4V ELI
	RS3800	RS Straight Titanium Abutment - No End Line	Ti 6Al 4V ELI
	RS3801	RS Straight Titanium Abutment 1mm	Ti 6Al 4V ELI
	RS3802	RS Straight Titanium Abutment 2mm	Ti 6Al 4V ELI
	RS3803	RS Straight Titanium Abutment 3mm	Ti 6Al 4V ELI
	RS3804	RS Straight Titanium Abutment 4mm	Ti 6Al 4V ELI
	RS3805	RS Straight Titanium Abutment 5 mm	Ti 6Al 4V ELI
	RS3811	RS Straight Titanium Abutment Long 12.5mm	Ti 6Al 4V ELI
	RS0010	RS Esthetic Straight Abutment 1mmL	Ti 6Al 4V ELI
	RS0011	RS Esthetic Straight Abutment 2mmL	Ti 6Al 4V ELI
	RS0012	RS Esthetic Straight Abutment 3mmL	Ti 6Al 4V ELI













Cement Retained

	RS3950	RS Titanium Abutment 5.0 mmD Wide	Ti 6Al 4V ELI
	RS3890	RS Wide Profile Titanium Abutment	Ti 6Al 4V ELI
	RS3411	RS Engaging Straight Cylindrical Titanium Abutment 2mm	Ti 6Al 4V ELI
	RS3422	RS Non-Engaging Straight Cylindrical Titanium Abutment 2mm	Ti 6Al 4V ELI
	RS3812	RS One Piece Screw-in Abutment	Ti 6Al 4V ELI
	RS4015	RS Angled Titanium Abutment 15°	Ti 6Al 4V ELI
	RS4016	RS Angled Titanium Abutment 15° - Long	Ti 6Al 4V ELI
	RS4017	RS Slim Angled Abutment 15° 1mm - No End Line	Ti 6Al 4V ELI
	RS4018	RS Slim Angled Abutment 15° 2mm - No End Line	Ti 6Al 4V ELI
	RS4019	RS Slim Angled Abutment 15° 3mm - No End Line	Ti 6Al 4V ELI
	RS4025	RS Angled Titanium Abutment 25°	Ti 6Al 4V ELI
	RS4035	RS Angled Titanium Abutment 35°	Ti 6Al 4V ELI
	RS4115	RS Esthetic Angled Titanium Abutment 15° 1mm	Ti 6Al 4V ELI
	RS4117	RS Esthetic Angled Titanium Abutment 15° 2mm	Ti 6Al 4V ELI
	RS4119	RS Esthetic Angled Titanium Abutment 15° 3mm	Ti 6Al 4V ELI
	RS3090	RS Engaging Gold / Plastic Abutment	Gold/POM
	RS3095	RS Engaging Titanium / Plastic Abutment	Ti 6Al 4V ELI/POM
	RS3097	RS Non Engaging Titanium/Plastic Abutment	Ti 6Al 4V ELI/POM
	RS5000	RS Engaging Plastic Cylinder Casting Abutment	POM
	RS5020	RS Non-Engaging Plastic Cylinder Casting Abutment	POM
	RS5030	RS Engaging Plastic Standard Abutment	POM
	RS5050	RS Non-Engaging Plastic Standard Abutment	POM
	RS5010	RS Engaging Plastic Casting Standard Abutment	POM
	RS5040	RS Engaging Plastic Cylinder Abutment	POM

Screw Retained - MU Trans Mucosal Abutments (TMA™)











	RS3731	RS Straight Trans Mucosal Abutment 1mm	Ti 6Al 4V ELI
	RS3732	RS Straight Trans Mucosal Abutment 2mm	Ti 6Al 4V ELI
	RS3733	RS Straight Trans Mucosal Abutment 3mm	Ti 6Al 4V ELI
	RS3729	RS Straight Trans Mucosal Abutment 4mm	Ti 6Al 4V ELI

Screw Retained - MU Trans Mucosal Abutments (TMA™)

	RS3730	RS Straight Trans Mucosal Abutment 5mm	Ti 6Al 4V ELI
	RS3734	RS Angled Trans Mucosal Abutment 17° 2mm	Ti 6Al 4V ELI
	RS3737	RS Angled Trans Mucosal Abutment 17° 3mm	Ti 6Al 4V ELI
	RS3735	RS Angled Trans Mucosal Abutment 30° 3mm	Ti 6Al 4V ELI
	RS3738	RS Angled Trans Mucosal Abutment 30° 4mm	Ti 6Al 4V ELI
	RS3736	RS Angled Trans Mucosal Abutment 45° 4mm	Ti 6Al 4V ELI
	RS5005	TMA Healing Cap	Ti 6Al 4V ELI
	RS4900	TMA Titanium Temporary Cylinder	Ti 6Al 4V ELI
	RS5001	TMA Plastic Casting Sleeve w / Prosthetic Screw	POM
	RS5004	TMA Abutment Replica	Ti 6Al 4V ELI
	RS5006	TMA Open Tray Transfer	Ti 6Al 4V ELI
	RS5011	RS TMA Closed Tray Transfer	Ti 6Al 4V ELI

* The term "impression coping" has been amended to the term "transfer" (the terms are synonymous). Please note that either term may appear in different documentation.

Screw Retained - Flat Connection

	FC4502	Flat Connection Abutment 2mm	Ti 6Al 4V ELI
	FC4504	Flat Connection Abutment 4mm	Ti 6Al 4V ELI
	FC5512	Flat Connection Transfer	Ti 6Al 4V ELI
	FC5515	Flat Connection Temporary Cylinder Sleeve	Ti 6Al 4V ELI
	FC5737	Flat Connection Implant Replica	Stainless Steel
	FC6011	Flat Connection Castable Abutment for Centering Ring	POM
	FC6015	Flat Connection Titanium Retaining Screw	Ti 6Al 4V ELI
	FC6013	Flat Connection Titanium Gluing Ring	Ti 6Al 4V ELI
	FC6017	Flat Connection Long Laboratory Screw	Ti 6Al 4V ELI
	FC6018	Flat Connection Centering Ring	Ti 6Al 4V ELI



Ball Attachment - Overdentures

	RS2861	RS Ball Attachment 1mm w / Hex	Ti 6Al 4V ELI
	RS2862	RS Ball Attachment 2mm w / Hex	Ti 6Al 4V ELI
	RS2863	RS Ball Attachment 3mm w / hex	Ti 6Al 4V ELI
	RS2864	RS Ball Attachment 4mm w / Hex	Ti 6Al 4V ELI









Ball Attachment - Overdentures

	RS2865	RS Ball Attachment 5mm w / Hex	Ti 6Al 4V ELI
	RS2866	RS Ball Attachment 6mm w / Hex	Ti 6Al 4V ELI
	RS2660	Plastic Ball Cap - White	Nylon
	RS2662	Plastic Ball Cap Pink - Soft	Nylon
	RS2670	Titanium Ball Cap	Ti 6Al 4V ELI
	RS2675SS	Stainless Steel Ball Cap	Stainless Steel

Analogs

	RS5737	RS Internal Hex Implant Analog	Stainless Steel
	RS5740	Ball Attachment Abutment Replica	Stainless Steel

Transfers / Impression Coping

	RS3510	RS Open Tray Slim Transfer 3.6mmDx10mmL	Ti 6Al 4V ELI
	RS3514	RS Open Tray Slim Transfer 3.6mmDx14mmL	Ti 6Al 4V ELI
	RS4510	RS Open Tray Transfer 4.5mmDx10mmL	Ti 6Al 4V ELI
	RS4514	RS Open Tray Transfer 4.5mmDx14mmL	Ti 6Al 4V ELI
	RS5109	RS Slim Closed Tray Transfer 3.5mmDx9mmL	Ti 6Al 4V ELI
	RS5209	RS Closed Tray Transfer 4.5mmDx9mmL	Ti 6Al 4V ELI
	RS5113	RS Slim Closed Tray Transfer 3.5mmDx13mmL	Ti 6Al 4V ELI
	RS5213	RS Closed Tray Transfer 4.5mmDx13mmL	Ti 6Al 4V ELI





* Transfers can be tightened by Hex Driver.

* Transfers will be chosen by length and width according to the planned prosthetic treatment and according to the interocclusal distance.









RS Retrieval Screw

	RS3401	RS Retrieval Screw For Abutments	Ti 6Al 4V ELI
---	--------	----------------------------------	---------------

RS Screws





	RS3435	RS Implant Cover Screw	Ti 6Al 4V ELI
	RS3400	RS Prosthetic Screw	Ti 6Al 4V ELI
	RS3402	RS Short Prosthetic Screw	Ti 6Al 4V ELI
	RS3480	RS Screw for Angled Titanium Abutment	Ti 6Al 4V ELI
	RS3403	RS Retaining Screw For Angled TMA	Ti 6Al 4V ELI

RS Screws







	RS3404	TMA Prosthetic Screw	Ti 6Al 4V ELI
	RS3406	RS Retaining Screw for TMA 1mm	Ti 6Al 4V ELI
	RS3407	RS Retaining Screw for TMA 2mm	Ti 6Al 4V ELI
	RS3408	RS Retaining Screw for TMA 3mm	Ti 6Al 4V ELI
	RS3409	RS Retaining Screw for TMA 4mm	Ti 6Al 4V ELI
	RS3412	RS Retaining Screw for TMA 5mm	Ti 6Al 4V ELI
	RS5008	TMA Screw For Open Tray Transfer	Ti 6Al 4V ELI
	RS5126	RS Closed Tray Transfer Screw Short	Ti 6Al 4V ELI
	RS5127	RS Closed Tray Transfer Screw Long	Ti 6Al 4V ELI

* All systems are provided with their compatible screws. However, they may also be ordered individually.

Prosthetic Hand Drivers

	RS6095	1.27 Hex Hand Driver - Short	Stainless Steel
	RS6094	1.27 Hex Hand Driver - Medium	Stainless Steel
	RS6097	1.27 Hex Hand Driver - Long	Stainless Steel
	RS6191	TMA/FC Female Hand Hex Driver - Long	Stainless Steel
	RS6193	TMA/FC Female Hand Hex Driver - Short	Stainless Steel

Torque Drivers

	RS6011	RS 2.4 Hex Torque Driver - Short	Stainless Steel
	RS6012	RS 2.4 Hex Torque Driver - Long	Stainless Steel
	RS6080	1.27 Hex Torque Driver - Short	Stainless Steel
	RS6082	1.27 Hex Torque Driver - Long	Stainless Steel
	RS6090	Torque Driver for Ball Attachment	Stainless Steel
	RS6197	TMA/FC Hex Torque Driver - Short	Stainless Steel
	RS6196	TMA/FC Hex Torque Driver - Long	Stainless Steel

Handpiece Drivers and Adaptors

	RS9021	RS Hex Handpiece Adapter - Short 24mm	Stainless Steel
	RS9026	RS Hex Handpiece Adapter - Medium 29mm	Stainless Steel
	RS9029	RS Hex Handpiece Adapter - Long 36mm	Stainless Steel
	RS9020	RS Hex Handpiece Adapter - Short 20mm	Stainless Steel
	RS9025	RS Hex Handpiece Adapter - Long 25mm	Stainless Steel
	RS9030	1.27 Hex Driver for Handpiece - Short	Stainless Steel
	RS9035	1.27 Hex Driver for Handpiece - Long	Stainless Steel
	RS6194	TMA /FC Hex Handpiece Adapter - Short	Stainless Steel
	RS6195A	TMA /FC Hex Handpiece Adapter - Long	Stainless Steel

One™

One™

AB/AE Surface Treatment

One Piece Implant System



One™ is a tapered core spiral implant. It is as easy to use as regular crown and bridge dentistry.

- Immediate Function / Loading
- Designed for Narrow Ridges
- Offers Fast and Easy Flapless Procedure
- One™ Implants with Narrow Diameters are Highly Suitable Replacements for Laterals in the Maxilla and Incisors in the Mandible
- Minimally Invasive Surgery When Using Narrow Diameter

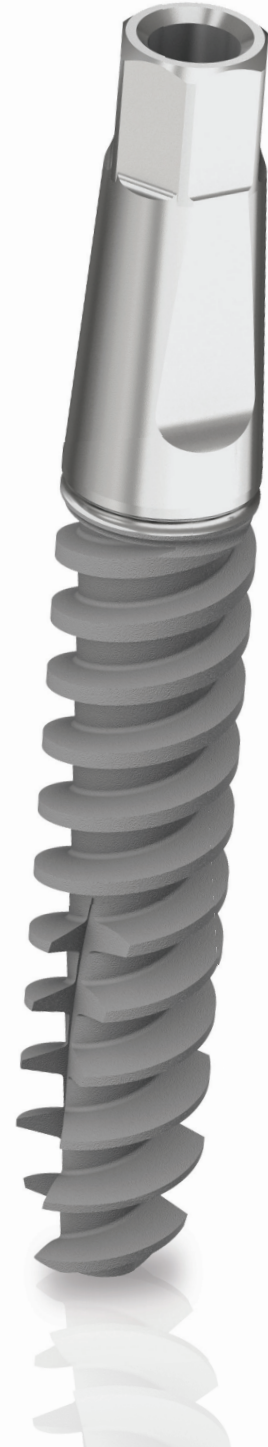
	L-10mm	L-11.5mm	L-13mm	L-15mm
IO-Ø3.0mm	IO1030	IO1130	IO1330	IO1530
IO-Ø3.3mm	IO1033	IO1133	IO1333	IO1533
IO-Ø3.6mm	IO1036	IO1136	IO1336	IO1536
IO-Ø4.2mm	IO1042	IO1142	IO1342	IO1542
IO-Ø5.0mm	IO1050	IO1150	IO1350	IO1550



Packed with:

Optional:		RS6025	RS One Piece Torque Driver - Short	Stainless Steel
		RS6026	RS One Piece Torque Driver - Long	Stainless Steel

One™ Ø3.0

AB/AE Surface
Titanium Alloy - Ti 6Al 4V ELI

Catalog No.	Length mm		
IO1030	10		
IO1130	11.5		
IO1330	13		
IO1530	15		

Drill Sequence

BONE TYPE D-IV	BONE TYPE D-II & III	BONE TYPE D-I
1. 2.0	1. 2.0 2. (2.8)	1. 2.0 2. 2.8

Note: (x.xx) drill to the depth of the cortex only. All measurements are in mm.

⚠ CAUTION: The drill preparation is up to 1mm longer than the implant.

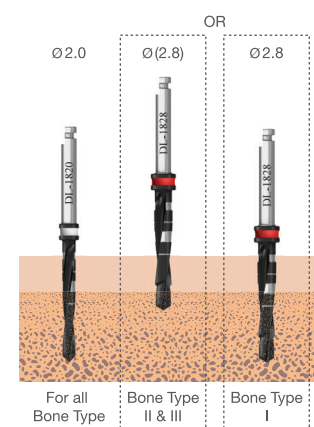

Radiographic Template

ASD0614 | Radiographic Template One™

One™ Ø3.3

AB/AE Surface
Titanium Alloy - Ti 6Al 4V ELI

Catalog No.	Length mm		
IO1033	10		
IO1133	11.5		
IO1333	13		
IO1533	15		

Drill Sequence

BONE TYPE D-IV	BONE TYPE D-II & III	BONE TYPE D-I
1. 2.0	1. 2.0 2. (2.8)	1. 2.0 2. 2.8

Note: (x.xx) drill to the depth of the cortex only. All measurements are in mm.

⚠ CAUTION: The drill preparation is up to 1mm longer than the implant.

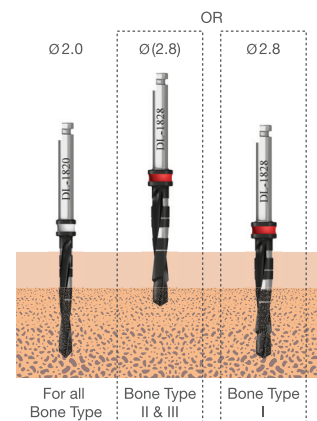

Radiographic Template

One™ Ø3.6

AB/AE Surface
Titanium Alloy - Ti 6Al 4V ELI

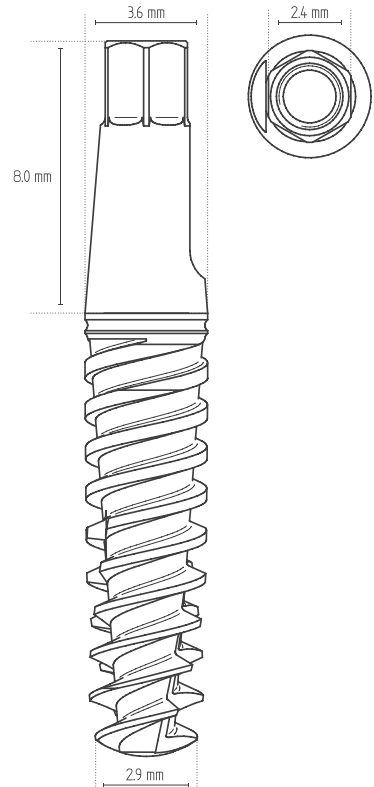
Catalog No.	Length mm		
IO1036	10		
IO1136	11.5		
IO1336	13		
IO1536	15		

Drill Sequence

BONE TYPE D-IV	BONE TYPE D-II & III	BONE TYPE D-I
1. Tri-Step*	1. Tri-Step* 2. (3.2)	1. Tri-Step* 2. (3.2)

Note: (x.xx) drill to the depth of the cortex only. All measurements are in mm.

⚠ CAUTION: The drill preparation is up to 1mm longer than the implant.

* For initial drilling, you may use 2, 2.8 and 3.2 drills in sequence instead of the Tri-Step drill.

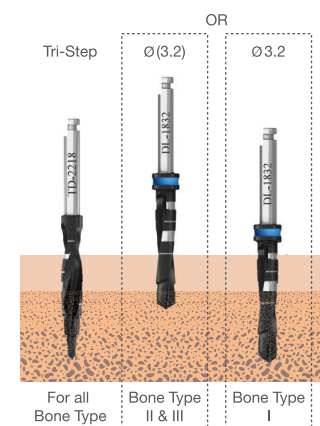

Radiographic Template

ASD0614 | Radiographic Template One™

One™ Ø4.2

AB/AE Surface
Titanium Alloy - Ti 6Al 4V ELI

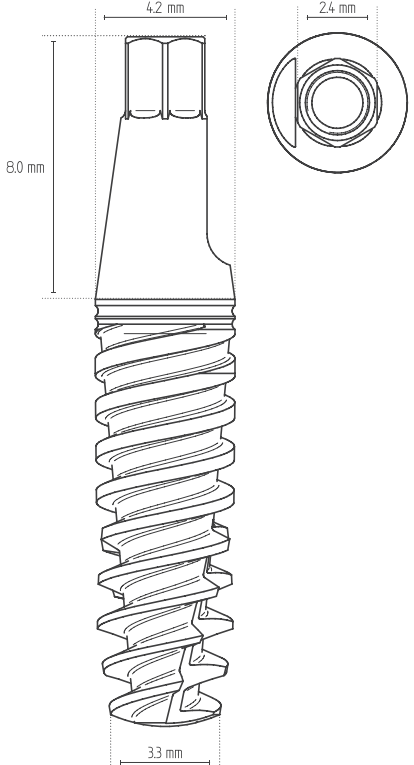
Catalog No.	Length mm		
IO1042	10		
IO1142	11.5		
IO1342	13		
IO1542	15		

Drill Sequence

BONE TYPE D-IV	BONE TYPE D-II & III	BONE TYPE D-I
1. Tri-Step* 2. (3.6)	1. Tri-Step* 2. (3.6)	1. Tri-Step* 2. 3.6

Note: (x.xx) drill to the depth of the cortex only. All measurements are in mm.

⚠ CAUTION: The drill preparation is up to 1mm longer than the implant.

* For initial drilling, you may use 2, 2.8 and 3.2 drills in sequence instead of the Tri-Step drill.

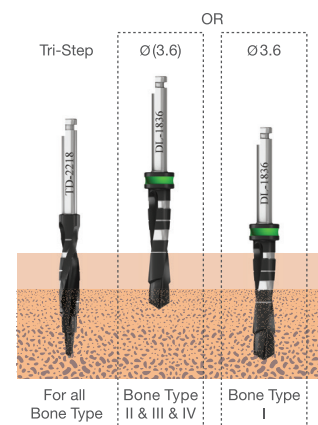

Radiographic Template

One™ Ø5.0

AB/AE Surface
Titanium Alloy - Ti 6Al 4V ELI

Catalog No.	Length mm	
IO1050	10	
IO1150	11.5	
IO1350	13	
IO1550	15	

Drill Sequence

BONE TYPE D-IV	BONE TYPE D-II & III	BONE TYPE D-I
1. Tri-Step*	1. Tri-Step*	1. Tri-Step*
2. 3.6	2. 3.6	2. 3.6
3. (4.2)	3. 4.2	3. 4.2
	4. (4.6)	4. 4.6

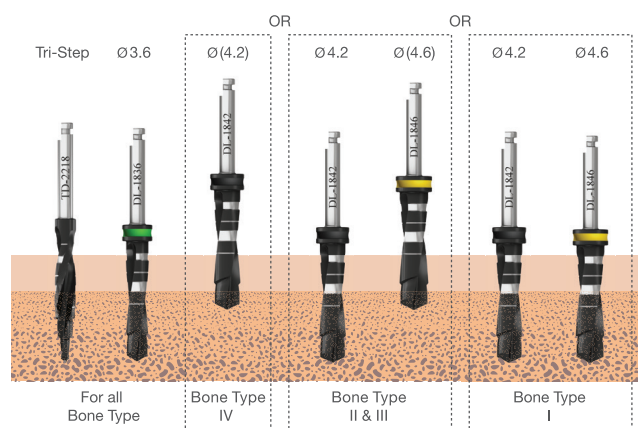

Note: (x.xx) drill to the depth of the cortex only.
All measurements are in mm.

⚠ CAUTION: The drill preparation is up to 1mm longer than the implant.

* For initial drilling, you may use 2, 2.8 and 3.2 drills in sequence instead of the Tri-Step drill.

Radiographic Template

ASD0614 | Radiographic Template One™

Kits & Tools

CloseFit™ Surgical Kit

Premium + UNP Starter Surgical Package



CF6300: CloseFit™ Surgical Kit - Premium

RS6111	Surgical Torque Ratchet 35 -100Ncm	RS8032	Tip Drill
RS6180	Depth Probe	RS9027	Drill Extension
RS6150	Parallel Pin 11	RP0064	Star Hand Driver-Short
RS6155	Parallel Pin 16	RP0004	Star Hand Driver - Long
DL1820	Pilot Drill 2mmD x 8-18mmL	TD1511	Three Step Drill-Short
DL1828	Twist Step Drill 2.3/2.8mmD x 8-18mmL	TD2218	Three Step Drill-Long
DL1832	Twist Step Drill 2.8/3.2mmD x 8-18mmL	NP0068	NP 2mm Hex Handpiece Adapter - Short
DL1836	Twist Step Drill 3.2/3.6mmD x 8-18mmL	NP0071	NP 2mm Hex Handpiece Adapter - Medium
DL1842	Twist Step Drill 3.8/4.2mmD x 8-18mmL	NP0074	NP 2mm Hex Handpiece Adapter - Long
DL1846	Twist Step Drill 4.2/4.6mmD x 8-18mmL	RP0068	RP 2.25mm Hex Handpiece Adapter - Short
DL1320	Pilot Drill 2mmD x 6-13mmL	RP0071	RP 2.25mm Hex Handpiece Adapter - Medium
DL1328	Twist Step Drill 2.3/2.8mmD x 6-13mmL	RP0074	RP 2.25mm Hex Handpiece Adapter - Long
DL1332	Twist Step Drill 2.8/3.2mmD x 6-13mmL	WP0068	WP 2.65mm Hex Handpiece Adapter - Short
DL1336	Twist Step Drill 3.2/3.6mmD x 6-13mmL	WP0071	WP 2.65mm Hex Handpiece Adapter - Medium
DL1342	Twist Step Drill 3.8/4.2mmD x 6-13mmL	WP0074	WP 2.65mm Hex Handpiece Adapter - Long
DL1346	Twist Step Drill 4.2/4.6mmD x 6-13mmL	RA0050	Wrench Ratchet Surgical Instruments Handle

CF6302: CloseFit™ Surgical Kit - Advanced

RS6111	Surgical Torque Ratchet 35-100 Ncm	RP0004	Star Hand Driver - Long
RS6180	Depth Probe	NP0068	NP 2mm Hex Handpiece Adapter - Short
RS6150	Parallel Pin 11	NP0071	NP 2mm Hex Handpiece Adapter - Medium
RS6155	Parallel Pin 16	NP0074	NP 2mm Hex Handpiece Adapter - Long
DL1820	Pilot Drill 2mmD x 8-18mmL	RP0068	RP 2.25mm Hex Handpiece Adapter - Short
DL1828	Twist Step Drill 2.3/2.8mmD x 8-18mmL	RP0071	RP 2.25mm Hex Handpiece Adapter - Medium
DL1832	Twist Step Drill 2.8/3.2mmD x 8-18mmL	RP0074	RP 2.25mm Hex Handpiece Adapter - Long
DL1836	Twist Step Drill 3.2/3.6mmD x 8-18mmL	WP0068	WP 2.65mm Hex Handpiece Adapter - Short
DL1842	Twist Step Drill 3.8/4.2mmD x 8-18mmL	WP0071	WP 2.65mm Hex Handpiece Adapter - Medium
DL1846	Twist Step Drill 4.2/4.6mmD x 8-18mmL	WP0074	WP 2.65mm Hex Handpiece Adapter - Long
RS9027	Drill Extension	RA0050	Wrench Ratchet Surgical Instruments Handle
RP0064	Star Hand Driver-Short		

Also available with short drills

CF6304 CloseFit™ Surgical Kit-Advanced Short Drills

CF6303: CloseFit™ Surgical Kit - Starter

RS6100	Wrench Ratchet	NP0074	NP 2mm Hex Handpiece Adapter - Long
DL1820	Pilot Drill 2mmD x 8-18mmL	RP0068	RP 2.25mm Hex Handpiece Adapter - Short
DL1828	Twist Step Drill 2.3/2.8mmD x 8-18mmL	RP0071	RP 2.25mm Hex Handpiece Adapter - Medium
DL1832	Twist Step Drill 2.8/3.2mmD x 8-18mmL	RP0074	RP 2.25mm Hex Handpiece Adapter - Long
DL1836	Twist Step Drill 3.2/3.6mmD x 8-18mmL	WP0068	WP 2.65mm Hex Handpiece Adapter - Short
RP0064	Star Hand Driver - Short	WP0071	WP 2.65mm Hex Handpiece Adapter - Medium
RP0004	Star Hand Driver - Long	WP0074	WP 2.65mm Hex Handpiece Adapter - Long
NP0068	NP 2mm Hex Handpiece Adapter - Short	RA0050	Wrench Ratchet Surgical Instruments Handle
NP0071	NP 2mm Hex Handpiece Adapter - Medium		

Also available with short drills

CF6305 CloseFit™ Surgical Kit-Starter Short Drills

Tools & Drills for CloseFit UNP are not included in the kit.
You may order it separately.

UNP6301: UNP Starter Surgical Package

DL1325	Twist Step Drill 1.8/2.5mmD x 6-13mmL	UNP0074	UNP 2mm Hex Handpiece Adapter - Long
DL1825	Twist Step Drill 1.8/2.5mmD x 8-18mmL	RP0050	Star Torque Driver Long
UNP0068	UNP 2mm Hex Handpiece Adapter - Short	RA0050	Wrench Ratchet Surgical Instruments Handle
UNP0071	UNP 2mm Hex Handpiece Adapter - Medium		

Touareg™ RS- Standard Internal Hex Surgical Kit Premium



RS6301: RS Standard Internal Hex Surgical Kit - Premium

RS6111	Surgical Torque Ratchet 35-100 Ncm	DL1352	Twist Step Drill 4.8/5.2mmD x 6-13mmL
RS6180	Depth Probe	DL1356	Twist Step Drill 5.2/5.6mmD x 6-13mmL
DL1820	Pilot Drill 2mmD x 8-18mmL	RS6150	Parallel Pin 11
DL1828	Twist Step Drill 2.3/2.8mmD x 8-18mmL	RS6155	Parallel Pin 16
DL1832	Twist Step Drill 2.8/3.2mmD x 8-18mmL	RS8032	Tip Drill
DL1836	Twist Step Drill 3.2/3.6mmD x 8-18mmL	RS9027	Drill Extension
DL1842	Twist Step Drill 3.8/4.2mmD x 8-18mmL	RS6095	1.27 Hex Hand Driver-Short
DL1846	Twist Step Drill 4.2/4.6mmD x 8-18mmL	RS6094	1.27 Hex Hand Driver-Medium
DL1852	Twist Step Drill 4.8/5.2mmD x 8-18mmL	TD1511	Three Step Drill-Short
DL1320	Pilot Drill 2mmD x 6-13mmL	TD2218	Three Step Drill-Long
DL1328	Twist Step Drill 2.3/2.8mmD x 6-13mmL	RS9021	RS Hex Handpiece Adapter - Short
DL1332	Twist Step Drill 2.8/3.2mmD x 6-13mmL	RS9026	RS Hex Handpiece Adapter - Medium
DL1336	Twist Step Drill 3.2/3.6mmD x 6-13mmL	RS9029	RS Hex Handpiece Adapter - Long
DL1342	Twist Step Drill 3.8/4.2mmD x 6-13mmL	RA0050	Wrench Ratchet Surgical Instruments Handle
DL1346	Twist Step Drill 4.2/4.6mmD x 6-13mmL		

RS6322: RS Standard Internal Hex Surgical Kit - Advanced

RS6111	Surgical Torque Ratchet 35-100 Ncm	RS6155	Parallel Pin 16
RS6180	Depth Probe	RS9027	Drill Extension
DL1820	Pilot Drill 2mmD x 8-18mmL	RS6095	1.27 Hex Hand Driver-Short
DL1828	Twist Step Drill 2.3/2.8mmD x 8-18mm	RS6094	1.27 Hex Hand Driver-Medium
DL1832	Twist Step Drill 2.8/3.2mmD x 8-18mmL	RS9021	RS Hex Handpiece Adapter - Short
DL1836	Twist Step Drill 3.2/3.6mmD x 8-18mmL	RS9026	RS Hex Handpiece Adapter - Medium
DL1842	Twist Step Drill 3.8/4.2mmD x 8-18mmL	RS9029	RS Hex Handpiece Adapter - Long
DL1846	Twist Step Drill 4.2/4.6mmD x 8-18mmL	RA0050	Wrench Ratchet Surgical Instruments Handle
RS6150	Parallel Pin 11		

Also available with short drills

RS6324 RS-Standard Internal Hex Surgical Kit-Advanced Short Drills

RS6333: RS Standard Internal Hex Surgical Kit - Starter

RS6100	Wrench Ratchet	RS6095	1.27 Hex Hand Driver-Short
DL1820	Pilot Drill 2mmD x 8-18mmL	RS6094	1.27 Hex Hand Driver-Medium
DL1828	Twist Step Drill 2.3/2.8mmD x 8-18mmL	RS9021	RS Hex Handpiece Adapter - Short
DL1832	Twist Step Drill 2.8/3.2mmD x 8-18mmL	RS9026	RS Hex Handpiece Adapter - Medium
DL1836	Twist Step Drill 3.2/3.6mmD x 8-18mmL	RS9029	RS Hex Handpiece Adapter - Long
DL1842	Twist Step Drill 3.8/4.2mmD x 8-18mmL	RA0050	Wrench Ratchet Surgical Instruments Handle
DL1846	Twist Step Drill 4.2/4.6mmD x 8-18mmL		

Also available with short drills

RS6334 RS-Standard Internal Hex Surgical Kit-Starter Short Drills

Prosthetic Kit



PK6300: Prosthetic Kit

RS6112 Prosthetic Torque Ratchet 15-35 Ncm
 RP0065 Star Torque Driver - Short
 RP0005 Star Torque Driver - Long
 RP0018 Star Handpiece Driver - Short
 RP0019 Star Handpiece Driver - Long
 RP0064 Star Hand Driver - Short
 RP0004 Star Hand Driver - Long
 RS6090 Torque Driver for Ball Attachment
 NP0014 NP Retrieval Screw for Abutments
 RP3401 RP Retrieval Screw for Abutments
 WP3401 WP Retrieval Screw for Abutments
 RS3401 RS Retrieval Screw for Abutments

RS6095 1.27 Hex Hand Driver - Short
 RS6094 1.27 Hex Hand Driver - Medium
 RS6080 1.27 Hex Torque Driver - Short
 RS6082 1.27 Hex Torque Driver - Long
 RS9030 1.27 Hex Driver for Handpiece - Short
 RS9035 1.27 Hex Driver for Handpiece - Long
 RS6193 TMA/FC Female Hand Hex Driver - Short
 RS6191 TMA/FC Female Hand Hex Driver - Long
 RS6197 TMA/FC Hex Torque Driver - Short
 RS6196 TMA/FC Hex Torque Driver - Long
 RS6194 TMA/FC Hex Handpiece Adapter - Short
 RS6195A TMA/FC Hex Handpiece Adapter - Long

Tools

Tools

RS6111



Surgical Torque Ratchet 35-100 Ncm
| Stainless Steel

RA0050



Wrench Ratchet Surgical Instruments Handle
| Stainless Steel

RS6112



Prosthetic Torque Ratchet 15-35 Ncm
| Stainless Steel

RS6100



Wrench Ratchet | Stainless Steel

RS7001



Surgical Driver | Stainless Steel

RS6180



Depth Probe | Stainless Steel

RS6150



Parallel Pin 11
| Stainless Steel

RS6155



Parallel Pin 16
| Stainless Steel

Osteotomes

HA1000

Osteotome Kit including: HA0074, HA0061, HA0064, HA0067, HA0070

HA0074



Osteotome Handle | Aluminium + Stainless Steel

HA0061



Osteotome Insert 2.0mmD | Ti 6Al 4V ELI

HA0067



Osteotome Insert 3.25mmD | Ti 6Al 4V ELI

HA0064



























Osteotome Insert 2.8mmD | Ti 6Al 4V ELI

HA0070





Osteotome Insert 3.65mmD | Ti 6Al 4V ELI

CloseFit™ UNP / NP / RP / WP Surgical Tools

	UNP0068	UNP 2mm Hex Handpiece Adapter - Short	Stainless Steel
	UNP0071	UNP 2mm Hex Handpiece Adapter - Medium	Stainless Steel
	UNP0074	UNP 2mm Hex Handpiece Adapter - Long	Stainless Steel
	NP0068	NP 2mm Hex Handpiece Adapter - Short 24mm	Stainless Steel
	NP0071	NP 2mm Hex Handpiece Adapter - Medium 28mm	Stainless Steel
	NP0074	NP 2mm Hex Handpiece Adapter - Long 36mm	Stainless Steel
	NP0062	NP 2mm Hex Handpiece Adapter - Short 20mm	Stainless Steel
	NP0072	NP 2mm Hex Handpiece Adapter - Long 25mm	Stainless Steel
	NP0006	NP 2mm Torque Driver - Short	Stainless Steel
	NP0005	NP 2mm Torque Driver - Long	Stainless Steel
	RP0068	RP 2.25mm Hex Handpiece Adapter - Short	Stainless Steel
	RP0071	RP 2.25mm Hex Handpiece Adapter - Medium	Stainless Steel
	RP0074	RP 2.25mm Hex Handpiece Adapter - Long	Stainless Steel
	RP0062	RP Handpiece Hex Adapter - Short	Stainless Steel
	RP0072	RP Handpiece Hex Adapter - Long	Stainless Steel
	RP0067	RP 2.2mm Hex Torque Driver - Short	Stainless Steel
	RP0066	RP 2.2mm Hex Torque Driver - Long	Stainless Steel
	WP0068	WP 2.65mm Hex Handpiece Adapter - Short	Stainless Steel
	WP0071	WP 2.65mm Hex Handpiece Adapter - Medium	Stainless Steel
	WP0074	WP 2.65mm Hex Handpiece Adapter - Long	Stainless Steel
	WP0062	WP Handpiece Hex Adapter - Short	Stainless Steel
	WP0072	WP Handpiece Hex Adapter - Long	Stainless Steel
	WP0067	WP 2.6mm Torque Driver - Short	Stainless Steel
	WP0066	WP 2.6mm Torque Driver - Long	Stainless Steel
	RA0050	Wrench Ratchet Surgical Instruments Handle	Stainless Steel

CloseFit™ UNP / NP / RP / WP Prosthetic Tools

	UNP1001	UNP/NP Abutment Insertion Tool	Stainless Steel
	RP0064	Star Hand Driver - Short	Stainless Steel
	RP0004	Star Hand Driver - Long	Stainless Steel
	RP0065	Star Torque Driver - Short	Stainless Steel
	RP0005	Star Torque Driver - Long	Stainless Steel
	RP0018	Star Handpiece Driver - Short	Stainless Steel
	RP0019	Star Handpiece Driver - Long	Stainless Steel
	RS6090	Torque Driver for Ball Attachment	Stainless Steel
	RS6194	TMA/ FC Hex Handpiece Adapter - Short	Stainless Steel
	RS6195A	TMA/ FC Hex Handpiece Adapter - Long	Stainless Steel
	RS6197	TMA/ FC Hex Torque Driver - Short	Stainless Steel
	RS6196	TMA/ FC Hex Torque Driver - Long	Stainless Steel
	RS6193	TMA/ FC Female Hand Hex Driver - Short	Stainless Steel
	RS6191	TMA/ FC Female Hand Hex Driver - Long	Stainless Steel



Standard Internal Hex Surgical Tools

	RS9021	RS Hex Handpiece Adapter - Short 24mm	Stainless Steel
	RS9026	RS Hex Handpiece Adapter - Medium 29mm	Stainless Steel
	RS9029	RS Hex Handpiece Adapter - Long 36mm	Stainless Steel
	RS9020	RS Hex Handpiece Adapter - Short 20mm	Stainless Steel
	RS9025	RS Hex Handpiece Adapter - Long 25mm	Stainless Steel
	RS6011	RS 2.4 Hex Torque Driver - Short	Stainless Steel
	RS6012	RS 2.4 Hex Torque Driver - Long	Stainless Steel
	RA0050	Wrench Ratchet Surgical Instruments Handle	Stainless Steel

Standard Internal Hex Prosthetic Tools

	RS6080	1.27 Hex Torque Driver - Short	Stainless Steel
	RS6082	1.27 Hex Torque Driver - Long	Stainless Steel
	RS9030	1.27 Hex Driver for Handpiece - Short	Stainless Steel
	RS9035	1.27 Hex Driver for Handpiece - Long	Stainless Steel
	RS6094	1.27 Hex Hand Driver - Medium	Stainless Steel
	RS6095	1.27 Hex Hand Driver - Short	Stainless Steel
	RS6097	1.27 Hex Hand Driver - Long	Stainless Steel
	RS6090	Torque Driver for Ball Attachment	Stainless Steel
	RS6194	TMA / FC Hex Handpiece Adapter - Short	Stainless Steel
	RS6195A	TMA / FC Hex Handpiece Adapter - Long	Stainless Steel
	RS6197	TMA / FC Hex Torque Driver - Short	Stainless Steel
	RS6196	TMA / FC Hex Torque Driver - Long	Stainless Steel
	RS6193	TMA / FC Female Hand Hex Driver - Short	Stainless Steel
	RS6191	TMA / FC Female Hand Hex Driver - Long	Stainless Steel

One Piece Tools









	RS6025	RS One Piece Torque Driver - Short	Stainless Steel
	RS6026	RS One Piece Torque Driver - Long	Stainless Steel

Friendly











Surgical Drills

Two Step DLC Drills - Long

	DL1820	Pilot Drill 2mmD x 8-18mmL White	White	Stainless Steel & DLC
	DL1825	Twist Step Drill 1.8/2.5mmD x 8-18mmL	Purple	Stainless Steel & DLC
	DL1828	Twist Step Drill 2.3/2.8mmD x 8-18mmL	Red	Stainless Steel & DLC
	DL1832	Twist Step Drill 2.8/3.2mmD x 8-18mmL	Blue	Stainless Steel & DLC
	DL1836	Twist Step Drill 3.2/3.6mmD x 8-18mmL	Green	Stainless Steel & DLC
	DL1842	Twist Step Drill 3.8/4.2mmD x 8-18mmL	Black	Stainless Steel & DLC
	DL1846	Twist Step Drill 4.2/4.6mmD x 8-18mmL	Yellow	Stainless Steel & DLC
	DL1852	Twist Step Drill 4.8/5.2mmD x 8-18mmL	Brown	Stainless Steel & DLC
	DL1856	Twist Step Drill 5.2/5.6mmD x 8-18mmL	Grey	Stainless Steel & DLC

Two Step DLC Drills - Short

	DL1320	Pilot Drill 2mmD x 6-13mmL	White	Stainless Steel & DLC
	DL1325	Twist Step Drill 1.8/2.5mmD x 6-13mmL	Purple	Stainless Steel & DLC
	DL1328	Twist Step Drill 2.3/2.8mmD x 6-13mmL	Red	Stainless Steel & DLC
	DL1332	Twist Step Drill 2.8/3.2mmD x 6-13mmL	Blue	Stainless Steel & DLC
	DL1336	Twist Step Drill 3.2/3.6mmD x 6-13mmL	Green	Stainless Steel & DLC
	DL1342	Twist Step Drill 3.8/4.2mmD x 6-13mmL	Black	Stainless Steel & DLC
	DL1346	Twist Step Drill 4.2/4.6mmD x 6-13mmL	Yellow	Stainless Steel & DLC
	DL1352	Twist Step Drill 4.8/5.2mmD x 6-13mmL	Brown	Stainless Steel & DLC
	DL1356	Twist Step Drill 5.2/5.6mmD x 6-13mmL	Grey	Stainless Steel & DLC

Three Step DLC Drills

	TD1511	Three Step Drill-Short	Stainless Steel & DLC
	TD2218	Three Step Drill-Long	Stainless Steel & DLC

Tip Drill

	RS8032	Tip Drill	Stainless Steel
---	--------	-----------	-----------------

Drill Extension

	RS9027	Drill Extension	Stainless Steel
---	--------	-----------------	-----------------

Drill Stoppers

Long Drill - Regular



Each Drill Stop is marked with width and length. Note: Some stops are suitable for long and short drill according to the following markings.

L: Drill length for long drill (18 mm)

S: Drill length for short drill (13 mm)

Short Drill 13mm

L	2.0mmD	2.8mmD	3.2mmD	3.6mmD	4.2mmD	4.6mmD	5.2mmD	5.6mmD
6mm	S1320L6	S1328L6	S1332L6	S1336L6	S1342L6	S1346L6	S1352L6	S1356L6
8mm	S1820L13	S1828L13	S1832L13	S1836L13	S1842L13	S1846L13	S1852L13	S1856L13
10mm	S1820L15	S1828L15	S1832L15	S1836L15	S1842L15	S1846L15	S1852L15	S1856L15
11.5mm	S1320L11.5	S1328L11.5	S1332L11.5	S1336L11.5	S1342L11.5	S1346L11.5	S1352L11.5	S1356L11.5

Long Drill 18mm

L	2.0mmD	2.8mmD	3.2mmD	3.6mmD	4.2mmD	4.6mmD	5.2mmD	5.6mmD
6mm	S1820L6	S1828L6	S1832L6	S1836L6	S1842L6	S1846L6	S1852L6	S1856L6
8mm	S1820L8	S1828L8	S1832L8	S1836L8	S1842L8	S1846L8	S1852L8	S1856L8
10mm	S1820L10	S1828L10	S1832L10	S1836L10	S1842L10	S1846L10	S1852L10	S1856L10
11.5mm	S1820L11.5	S1828L11.5	S1832L11.5	S1836L11.5	S1842L11.5	S1846L11.5	S1852L11.5	S1856L11.5
13mm	S1820L13	S1828L13	S1832L13	S1836L13	S1842L13	S1846L13	S1852L13	S1856L13
15mm	S1820L15	S1828L15	S1832L15	S1836L15	S1842L15	S1846L15	S1852L15	S1856L15
16mm	S1820L16	S1828L16	S1832L16	S1836L16	S1842L16	S1846L16	S1852L16	S1856L16

Drill Stop kits

- S1001 | Long Drill Stop Kit - Regular
- S1002 | Long Drill Stop Kit - Wide
- S1003 | Short Drill Stop Kit - Regular
- S1004 | Short Drill Stop Kit - Wide

Index in Alphabetical Order

Catalog No.	Description	Page No.	Catalog No.	Description	Page No.
RS9035	1.27 Hex Driver for Handpiece - Long	55,66,70,74	S1842L6	Drill Stop for Long L6 1842	73
RS9030	1.27 Hex Driver for Handpiece - Short	55,66,70,74	S1846L6	Drill Stop for Long L6 1846	73
RS6097	1.27 Hex Hand Driver - Long	55,70	S1852L6	Drill Stop for Long L6 1852	73
RS6094	1.27 Hex Hand Driver - Medium	55,65,66,70	S1856L6	Drill Stop for Long L6 1856	73
RS6095	1.27 Hex Hand Driver - Short	55,65,66,70	S1820L8	Drill Stop for Long L8 1820	73
RS6082	1.27 Hex Torque Driver - Long	55,66,70	S1828L8	Drill Stop for Long L8 1828	73
RS6080	1.27 Hex Torque Driver - Short	55,66,70	S1836L8	Drill Stop for Long L8 1836	73
B			S1842L8	Drill Stop for Long L8 1842	73
RS5740	Ball Attachment Abutment Replica	15,21,28,53	S1846L8	Drill Stop for Long L8 1846	73
C			S1852L8	Drill Stop for Long L8 1852	73
CF6302	CloseFit™ Surgical Kit - Advanced	63	S1856L8	Drill Stop for Long L8 1856	73
CF6304	CloseFit™ Surgical Kit - Advanced Short Drills	63	S1832L6	Drill Stop for LongL6 1832	73
CF6300	CloseFit™ Surgical Kit - Premium	63	S1832L8	Drill Stop for LongL8 1832	73
CF6303	CloseFit™ Surgical Kit - Starter	63	S1320L11.5	Drill Stop for Short L11.5 1320	73
CF6305	CloseFit™ Surgical Kit - Starter Short Drills	63	S1328L11.5	Drill Stop for Short L11.5 1328	73
D			S1332L11.5	Drill Stop for Short L11.5 1332	73
RS6180	Depth Probe	63,65,67	S1336L11.5	Drill Stop for Short L11.5 1336	73
RS9027	Drill Extension	63,65,72	S1342L11.5	Drill Stop for Short L11.5 1342	73
S1820L10	Drill Stop for Long L10 1820	73	S1346L11.5	Drill Stop for Short L11.5 1346	73
S1828L10	Drill Stop for Long L10 1828	73	S1352L11.5	Drill Stop for Short L11.5 1352	73
S1832L10	Drill Stop for Long L10 1832	73	S1356L11.5	Drill Stop for Short L11.5 1356	73
S1836L10	Drill Stop for Long L10 1836	73	S1320L6	Drill Stop for Short L6 1320	73
S1842L10	Drill Stop for Long L10 1842	73	S1328L6	Drill Stop for Short L6 1328	73
S1846L10	Drill Stop for Long L10 1846	73	S1332L6	Drill Stop for Short L6 1332	73
S1852L10	Drill Stop for Long L10 1852	73	S1336L6	Drill Stop for Short L6 1336	73
S1856L10	Drill Stop for Long L10 1856	73	S1342L6	Drill Stop for Short L6 1342	73
S1820L11.5	Drill Stop for Long L11.5 1820	73	S1346L6	Drill Stop for Short L6 1346	73
S1828L11.5	Drill Stop for Long L11.5 1828	73	S1352L6	Drill Stop for Short L6 1352	73
S1832L11.5	Drill Stop for Long L11.5 1832	73	S1356L6	Drill Stop for Short L6 1356	73
S1836L11.5	Drill Stop for Long L11.5 1836	73	F		
S1842L11.5	Drill Stop for Long L11.5 1842	73	FC4502	Flat Connection Abutment 2mm	52
S1846L11.5	Drill Stop for Long L11.5 1846	73	FC4504	Flat Connection Abutment 4mm	52
S1852L11.5	Drill Stop for Long L11.5 1852	73	FC6011	Flat Connection Castable Abutment for Centering Ring	14,20,27,52
S1856L11.5	Drill Stop for Long L11.5 1856	73	FC6018	Flat Connection Centering Ring	14,20,27,52
S1820L13	Drill Stop for Long L13/Short L8 1820	73	FC5737	Flat Connection Implant Replica	14,20,27,52
S1828L13	Drill Stop for Long L13/Short L8 1828	73	FC6017	Flat Connection Long Laboratory Screw	14,20,27,52
S1832L13	Drill Stop for Long L13/Short L8 1832	73	FC5515	Flat Connection Temporary Cylinder Sleeve	14,20,27,52
S1836L13	Drill Stop for Long L13/Short L8 1836	73	FC6013	Flat Connection Titanium Gluing Ring	14,20,27,52
S1842L13	Drill Stop for Long L13/Short L8 1842	73	FC6015	Flat Connection Titanium Retaining Screw	14,20,27,52
S1846L13	Drill Stop for Long L13/Short L8 1846	73	FC5512	Flat Connection Transfer	14,20,27,52
S1852L13	Drill Stop for Long L13/Short L8 1852	73	L		
S1856L13	Drill Stop for Long L13/Short L8 1856	73	S1001	Long Drill Stop Kit - Regular	73
S1820L15	Drill Stop for Long L15/Short L10 1820	73	S1002	Long Drill Stop Kit - Wide	73
S1828L15	Drill Stop for Long L15/Short L10 1828	73	N		
S1832L15	Drill Stop for Long L15/Short L10 1832	73	NP0072	NP 2mm Hex Handpiece Adapter - Long 25mm	16,68
S1836L15	Drill Stop for Long L15/Short L10 1836	73	NP0074	NP 2mm Hex Handpiece Adapter - Long 36mm	16,63,68
S1842L15	Drill Stop for Long L15/Short L10 1842	73	NP0071	NP 2mm Hex Handpiece Adapter - Medium 28mm	16,63,68
S1846L15	Drill Stop for Long L15/Short L10 1846	73	NP0062	NP 2mm Hex Handpiece Adapter - Short 20mm	16,68
S1852L15	Drill Stop for Long L15/Short L10 1852	73	NP0068	NP 2mm Hex Handpiece Adapter - Short 24mm	16,63,68
S1856L15	Drill Stop for Long L15/Short L10 1856	73	NP0005	NP 2mm Torque Driver - Long	16,68
S1820L16	Drill Stop for Long L16 1820	73	NP0006	NP 2mm Torque Driver - Short	16,68
S1828L16	Drill Stop for Long L16 1828	73	NP0001	NP Abutment Screw	15
S1832L16	Drill Stop for Long L16 1832	73	NP0015	NP Angled Abutment 15° 1mm	13
S1836L16	Drill Stop for Long L16 1836	73	NP0018	NP Angled Abutment 15° - No End Line	13
S1842L16	Drill Stop for Long L16 1842	73	NP0025	NP Angled Abutment 25° - No End Line	13
S1846L16	Drill Stop for Long L16 1846	73	NP0026	NP Angled Abutment 15° 2mm	13
S1852L16	Drill Stop for Long L16 1852	73	NP0063	NP Angled Abutment 15° 3mm	13
S1856L16	Drill Stop for Long L16 1856	73	NP0035	NP Angled Trans Mucosal Abutment 17° L=3mm	14
S1820L6	Drill Stop for Long L6 1820	73	NP0038	NP Angled Trans Mucosal Abutment 17° L=4mm	14
S1828L6	Drill Stop for Long L6 1828	73	NP0036	NP Angled Trans Mucosal Abutment 30° L=3.5mm	14
S1836L6	Drill Stop for Long L6 1836	73	NP0037	NP Angled Trans Mucosal Abutment 30° L=5mm	14

Catalog No.	Description	Page No.	Catalog No.	Description	Page No.
NP0020	NP Ball Attachment 0.5mm	15	IO1336	One™ Dental Implant 3.6D 13L	56,59
NP0021	NP Ball Attachment 1mm	15	IO1536	One™ Dental Implant 3.6D 15L	56,59
NP0022	NP Ball Attachment 2mm	15	IO1042	One™ Dental Implant 4.2D 10L	56,60
NP0023	NP Ball Attachment 3mm	15	IO1142	One™ Dental Implant 4.2D 11.5L	56,60
NP0024	NP Ball Attachment 4mm	15	IO1342	One™ Dental Implant 4.2D 13L	56,60
NP5213	NP Closed Tray Transfer 4.2mmDx13mmL	15	IO1542	One™ Dental Implant 4.2D 15L	56,60
NP5127	NP Closed Tray Transfer Screw	15	IO1050	One™ Dental Implant 5.0D 10L	56,61
NP0073	NP Conical Implant Cover Screw	13,15	IO1150	One™ Dental Implant 5.0D 11.5L	56,61
NP0090	NP Conical Healing Abutment 4.5mmD x 2mmL	13	IO1350	One™ Dental Implant 5.0D 13L	56,61
NP0091	NP Conical Healing Abutment 4.5mmD x 3mmL	13	IO1550	One™ Dental Implant 5.0D 15L	56,61
NP0092	NP Conical Healing Abutment 4.5mmD x 4mmL	13	HA0061	Osteotome insert 2.0mmD	67
NP0093	NP Conical Healing Abutment 4.5mmD x 5mmL	13	HA0064	Osteotome insert 2.8mmD	67
NP0094	NP Conical Healing Abutment 4.5mmD x 6mmL	13	HA0067	Osteotome insert 3.25mmD	67
ISPNP1030	NP Dental Implant 3.0D 10L	7,12	HA0070	Osteotome insert 3.65mmD	67
ISPNP1130	NP Dental Implant 3.0D 11.5L	7,12	HA1000	Osteotome Kit	67
ISPNP1330	NP Dental Implant 3.0D 13L	7,12			
ISPNP1630	NP Dental Implant 3.0D 16L	7,12			
ISPNP1830	NP Dental Implant 3.0D 18L	7,12			
NP0043	NP Engaging Temporary Abutment	13	RS6150	Parallel Pin 11	63,65,67
NP3095	NP Engaging Titanium / Plastic Abutment	14	RS6155	Parallel Pin 16	63,65,67
NP0030	NP Flat Connection Abutment 2mm	14	DL1320	Pilot Drill 2mmD x 6-13mmL	63,65,72
NP0031	NP Flat Connection Abutment 4mm	14	DL1820	Pilot Drill 2mmD x 8-18mmL	63,65,67
NP0004	NP Healing Abutment 4.5mmD x 2mmL	13	RS2662	Plastic Ball Cap Pink Soft	10,15,21,28,53
NP0008	NP Healing Abutment 4.5mmD x 3mmL	13	RS2660	Plastic Ball Cap White	10,15,21,28,53
NP0009	NP Healing Abutment 4.5mmD x 4mmL	13	PK6300	Prosthetic Kit Metal	66
NP0012	NP Healing Abutment 4.5mmD x 5mmL	13	RS6112	Prosthetic Torque Ratchet 15-35 Ncm	66,67
NP0013	NP Healing Abutment 4.5mmD x 6mmL	13			
NP0007	NP Implant Analog	15			
NP0044	NP Non Engaging Temporary Abutment	13	ASD0614	Radiographic Template One™	57,58,59,60,61
NP3097	NP Non-Engaging Titanium / Plastic Abutment	14	ASD0613	Radiographic Template Swell™	45,46,47,48,49
NP5514	NP Open Tray Transfer 4.2mmDx14mmL	15	ASD0611	Radiographic Template NP	12
NP5014	NP Open Tray Transfer Screw	15	ASD0612	Radiographic Template RP/WP	18,24,25
NP0045	NP Plastic Cylinder Abutment	13	ASD0610	Radiographic Template Touareg™ S/OS	34,35,36,37,38,39,40,41,42,43
NP0042	NP Retaining Screw for Angled TMA	15	ASD0615	Radiographic Template UNP	8
NP0039	NP Retaining Screw for TMA 1mm	15	RP0074	RP 2.25mm Hex Handpiece Adapter - Long	23,63,68
NP0040	NP Retaining Screw for TMA 2mm	15	RP0071	RP 2.25mm Hex Handpiece Adapter - Medium	23,63,68
NP0041	NP Retaining Screw for TMA 3mm	15	RP0068	RP 2.25mm Hex Handpiece Adapter - Short	23,63,68
NP3409	NP Retaining Screw for TMA 4mm	15	RP0066	RP 2.2mm Torque Driver - Long	23,68
NP3412	NP Retaining Screw for TMA 5mm	15	RP0067	RP 2.2mm Torque Driver - Short	23,68
NP0014	NP Retrieval Screw for Abutments	15,16,66	RP0001	RP Abutment Screw	22
NP5113	NP Slim Closed Tray Transfer 3.2mmDx13mmL	15	RP0013	RP Angled Abutment 15° 1mm	19
NP0046	NP Slim Healing Abutment 3mmD x 2mmL	13	RP0014	RP Angled Abutment 15° 2mm	19
NP0047	NP Slim Healing Abutment 3mmD x 3mmL	13	RP0015	RP Angled Abutment 15° 3mm	19
NP0048	NP Slim Healing Abutment 3mmD x 4mmL	13	RP3734	RP Angled Trans Mucosal Abutment 17° 2.5mm	20
NP0049	NP Slim Healing Abutment 3mmD x 5mmL	13	RP3737	RP Angled Trans Mucosal Abutment 17° 3.5mm	20
NP0050	NP Slim Healing Abutment 3mmD x 6mmL	13	RP3735	RP Angled Trans Mucosal Abutment 30° 3mm	20
NP5614	NP Slim Open Tray Transfer 3.2mmDx14mmL	15	RP3738	RP Angled Trans Mucosal Abutment 30° 4mm	20
NP0019	NP Straight Abutment 1mm	13	RP0051	RP Ball Attachment 0.5mm	21
NP0011	NP Straight Abutment 2mm	13	RP0052	RP Ball Attachment 1mm	21
NP0064	NP Straight Abutment 3mm	13	RP0053	RP Ball Attachment 2mm	21
NP0010	NP Straight Slim Abutment - No End Line	13	RP0054	RP Ball Attachment 3mm	21
NP0032	NP Straight Trans Mucosal Abutment 1mm	14	RP0055	RP Ball Attachment 4mm	21
NP0033	NP Straight Trans Mucosal Abutment 2mm	14	RP0056	RP Ball Attachment 5mm	21
NP0034	NP Straight Trans Mucosal Abutment 3mm	14	RP5209	RP Closed Tray Transfer 4.2mmDx9mmL	21
NP3729	NP Straight Trans Mucosal Abutment 4mm	14	RP5213	RP Closed Tray Transfer 4.2mmDx13mmL	21
NP3730	NP Straight Trans Mucosal Abutment 5mm	14	RP5127	RP Closed Tray Transfer Screw - Long	22
			RP5126	RP Closed Tray Transfer Screw - Short	22
			RP0090	RP Conical Healing Abutment 4.5mmD x 2mmL	19
			RP0091	RP Conical Healing Abutment 4.5mmD x 3mmL	19
			RP0092	RP Conical Healing Abutment 4.5mmD x 4mmL	19
			RP0093	RP Conical Healing Abutment 4.5mmD x 5mmL	19
			RP0094	RP Conical Healing Abutment 4.5mmD x 6mmL	19
			RP0073	RP Conical Implant Cover Screw	19,22
			ISPX1035	RP Dental Implant 3.5D 10L	7,18
			ISPX1135	RP Dental Implant 3.5D 11.5L	7,18
			ISPX1335	RP Dental Implant 3.5D 13L	7,18
			ISPX1535	RP Dental Implant 3.5D 15L	7,18
			ISPX1835	RP Dental Implant 3.5D 18L	7,18
			ISPX0835	RP Dental Implant 3.5D 8.0L	7,18
IO1030	One™ Dental Implant 3.0D 10L	56,57			
IO1130	One™ Dental Implant 3.0D 11.5L	56,57			
IO1330	One™ Dental Implant 3.0D 13L	56,57			
IO1530	One™ Dental Implant 3.0D 15L	56,57			
IO1033	One™ Dental Implant 3.3D 10L	56,58			
IO1133	One™ Dental Implant 3.3D 11.5L	56,58			
IO1333	One™ Dental Implant 3.3D 13L	56,58			
IO1533	One™ Dental Implant 3.3D 15L	56,58			
IO1036	One™ Dental Implant 3.6D 10L	56,59			
IO1136	One™ Dental Implant 3.6D 11.5L	56,59			

Catalog No.	Description	Page No.	Catalog No.	Description	Page No.
RP0045	RP Engaging Plastic Cylinder Abutment	19	RS5030	RS Engaging Plastic Standard Abutment	51
RP0043	RP Engaging Temporary Abutment	19	RS3411	RS Engaging Straight Cylindrical Titanium Abutment 2mm	51
RP3095	RP Engaging Titanium / Plastic Abutment	19	RS3095	RS Engaging Titanium / Plastic Abutment	51
RP0030	RP Flat Connection Abutment 2mm	20	RS4115	RS Esthetic Angled Titanium Abutment 15° 1mm	51
RP0031	RP Flat Connection Abutment 4mm	20	RS4117	RS Esthetic Angled Titanium Abutment 15° 2mm	51
RP0072	RP Handpiece Hex Adapter - Long	23,68	RS4119	RS Esthetic Angled Titanium Abutment 15° 3mm	51
RP0062	RP Handpiece Hex Adapter - Short	23,68	RS0010	RS Esthetic Straight Abutment 1mmL	50
RP0022	RP Healing Abutment 4.5mmD x 2mmL	19	RS0011	RS Esthetic Straight Abutment 2mmL	50
RP0023	RP Healing Abutment 4.5mmD x 3mmL	19	RS0012	RS Esthetic Straight Abutment 3mmL	50
RP0024	RP Healing Abutment 4.5mmD x 4mmL	19	RS3022	RS Healing Abutment 4.5mmD x 2mmL	50
RP0025	RP Healing Abutment 4.5mmD x 5mmL	19	RS3023	RS Healing Abutment 4.5mmD x 3mmL	50
RP0026	RP Healing Abutment 4.5mmD x 6mmL	19	RS3024	RS Healing Abutment 4.5mmD x 4mmL	50
RP0007	RP Implant Analog	21	RS3025	RS Healing Abutment 4.5mmD x 5mmL	50
RP0044	RP Non-Engaging Temporary Abutment	19	RS3026	RS Healing Abutment 4.5mmD x 6mmL	50
RP3097	RP Non-Engaging Titanium / Plastic Abutment	19	RS9025	RS Hex Handpiece Adapter - Long 25mm	55,70
RP5510	RP Open Tray Transfer 4.2mmDx10mmL	21	RS9029	RS Hex Handpiece Adapter - Long 36mm	55,65,70
RP5514	RP Open Tray Transfer 4.2mmDx14mmL	21	RS9026	RS Hex Handpiece Adapter - Medium 29mm	55,65,70
RP5014	RP Open Tray Transfer Screw - Long	22	RS9020	RS Hex Handpiece Adapter - Short 20mm	55,70
RP5010	RP Open Tray Transfer Screw - Short	22	RS9021	RS Hex Handpiece Adapter - Short 24mm	55,65,70
RP3403	RP Retaining Screw for Angled TMA	22	RS3435	RS Implant Cover Screw	50,53
RP0039	RP Retaining Screw For TMA 1mm	22	RS5737	RS Internal Hex Implant Analog	53
RP0040	RP Retaining Screw For TMA 2mm	22	RS5020	RS Non-Engaging Plastic Cylinder Casting Abutment	51
RP0041	RP Retaining Screw For TMA 3mm	22	RS5050	RS Non-Engaging Plastic Standard Abutment	51
RP3409	RP Retaining Screw for TMA 4mm	22	RS3422	RS Non-Engaging Straight Cylindrical Titanium Abutment 2mm	51
RP3412	RP Retaining Screw for TMA 5mm	22	RS3097	RS Non-Engaging Titanium / Plastic Abutment	51
RP3401	RP Retrieval Screw for Abutments	21,66	RS3812	RS One Piece Screw-In Abutment	51
RP5109	RP Slim Closed Tray Transfer 3.6mmDx9mmL	21	RS6026	RS One Piece Torque Driver - Long	56,70
RP5113	RP Slim Closed Tray Transfer 3.6mmDx13mmL	21	RS6025	RS One Piece Torque Driver - Short	56,70
RP0046	RP Slim Healing Abutment 3.5mmD x 2mmL	19	RS3510	RS Open Tray Slim Transfer 3.6mmDx10mmL	53
RP0047	RP Slim Healing Abutment 3.5mmD x 3mmL	19	RS3514	RS Open Tray Slim Transfer 3.6mmDx14mmL	53
RP0048	RP Slim Healing Abutment 3.5mmD x 4mmL	19	RS4510	RS Open Tray Transfer 4.5mmDx10mmL	53
RP0049	RP Slim Healing Abutment 3.5mmD x 5mmL	19	RS4514	RS Open Tray Transfer 4.5mmDx14mmL	53
RP0050	RP Slim Healing Abutment 3.5mmD x 6mmL	19,63	RS3400	RS Prosthetic Screw	53
RP5610	RP Slim Open Tray Transfer 3.6mmDx10mmL	21	RS3403	RS Retaining Screw For Angled TMA	53
RP5614	RP Slim Open Tray Transfer 3.6mmDx14mmL	21	RS3406	RS Retaining Screw for TMA 1mm	54
RP0012	RP Straight Abutment 1mm	19	RS3407	RS Retaining Screw for TMA 2mm	54
RP0011	RP Straight Abutment 2mm	19	RS3408	RS Retaining Screw for TMA 3mm	54
RP0010	RP Straight Abutment 3mm	19	RS3409	RS Retaining Screw for TMA 4mm	54
RP0020	RP Straight Slim Abutment - No End Line	19	RS3412	RS Retaining Screw for TMA 5mm	54
RP0032	RP Straight Trans Mucosal Abutment 1mm	20	RS3401	RS Retrieval Screw For Abutments	53,66
RP0033	RP Straight Trans Mucosal Abutment 2mm	20	RS3480	RS Screw for Angled Titanium Abutment	53
RP0034	RP Straight Trans Mucosal Abutment 3mm	20	RS3402	RS Short Prosthetic Screw	53
RP3729	RP Straight Trans Mucosal Abutment 4 mm	20	RS4017	RS Slim Angled Abutment 15° 1mm - No End Line	51
RP3730	RP Straight Trans Mucosal Abutment 5 mm	20	RS4018	RS Slim Angled Abutment 15° 2mm - No End Line	51
RS6012	RS 2.4 Hex Torque Driver - Long	55,70	RS4019	RS Slim Angled Abutment 15° 3mm - No End Line	51
RS6011	RS 2.4 Hex Torque Driver - Short	55,70	RS5109	RS Slim Closed Tray Transfer 3.5mmDx9mmL	53
RS4015	RS Angled Titanium Abutment 15°	51	RS5113	RS Slim Closed Tray Transfer 3.5mmDx13mmL	53
RS4016	RS Angled Titanium Abutment 15° Long	51	RS3027	RS Slim Healing Abutment 3.5mmD x 2mmL	50
RS4025	RS Angled Titanium Abutment 25°	51	RS3028	RS Slim Healing Abutment 3.5mmD x 3mmL	50
RS4035	RS Angled Titanium Abutment 35°	51	RS3029	RS Slim Healing Abutment 3.5mmD x 4mmL	50
RS3734	RS Angled Trans Mucosal Abutment 17° 2mm	52	RS3030	RS Slim Healing Abutment 3.5mmD x 5mmL	50
RS3737	RS Angled Trans Mucosal Abutment 17° 3mm	52	RS3031	RS Slim Healing Abutment 3.5mmD x 6mmL	50
RS3735	RS Angled Trans Mucosal Abutment 30° 3mm	52	RS3903	RS Slim Titanium Abutment 3mm	50
RS3738	RS Angled Trans Mucosal Abutment 30° 4mm	52	RS3906	RS Slim Titanium Abutment 6mm	50
RS3736	RS Angled Trans Mucosal Abutment 45° 4mm	52	RS3908	RS Slim Titanium Abutment 8mm	50
RS2861	RS Ball Attachment 1mm w/Hex	52	RS6322	RS Standard Internal Hex Plastic Surgical Kit - Advanced	65
RS2862	RS Ball Attachment 2mm w/Hex	52	RS6301	RS Standard Internal Hex Plastic Surgical Kit - Premium	65
RS2864	RS Ball Attachment 4mm w/Hex	52	RS6333	RS Standard Internal Hex Plastic Surgical Kit - Starter	65
RS2865	RS Ball Attachment 5mm w/Hex	52	RS6324	RS Standard Internal Hex Surgical Kit-Advanced Short Drills	65
RS2866	RS Ball Attachment 6mm w/Hex	53	RS6334	RS Standard Internal Hex Surgical Kit-Starter Short Drills	65
RS5209	RS Closed Tray Transfer 4.5mmDx9mmL	53	RS3800	RS Straight Titanium Abutment - No End Line	50
RS5213	RS Closed Tray Transfer 4.5mmDx13mmL	53	RS3801	RS Straight Titanium Abutment 1mm	50
RS5127	RS Closed Tray Transfer Screw Long	54	RS3802	RS Straight Titanium Abutment 2mm	50
RS5126	RS Closed Tray Transfer Screw Short	54	RS3803	RS Straight Titanium Abutment 3mm	50
RS3090	RS Engaging Gold / Plastic Abutment	51	RS3804	RS Straight Titanium Abutment 4mm	50
RS5010	RS Engaging Plastic Casting Standard Abutment	51	RS3805	RS Straight Titanium Abutment 5 mm	50
RS5040	RS Engaging Plastic Cylinder Abutment	51	RS3811	RS Straight Titanium Abutment Long 12.5mm	50
RS5000	RS Engaging Plastic Cylinder Casting Abutment	51	RS3731	RS Straight Trans Mucosal Abutment 1mm	51

Catalog No.	Description	Page No.	Catalog No.	Description	Page No.
RS3732	RS Straight Trans Mucosal Abutment 2mm	51	RS5001	TMA Plastic Casting Sleeve w/Prosthetic Screw	14,20,27,52
RS3733	RS Straight Trans Mucosal Abutment 3mm	51	RS3404	TMA Prosthetic Screw	53
RS3729	RS Straight Trans Mucosal Abutment 4 mm	51	RS5008	TMA Screw For Open Tray Impression Copying	54
RS3730	RS Straight Trans Mucosal Abutment 5 mm	52	RS4900	TMA Titanium Temporary Cylinder	14,20,27,52
RS3950	RS Titanium Abutment 5.0 mmD Wide	51	RS6090	Torque Driver for Ball Attachment	16,23,30,55,66,69,70
RS3012	RS Wide Healing Abutment 6mmD x 2mmL	50	ISF1035	Touareg™-OS Dental Implant 3.5D 10L	33,34
RS3013	RS Wide Healing Abutment 6mmD x 3mmL	50	ISF1135	Touareg™-OS Dental Implant 3.5D 11.5L	33,34
RS3014	RS Wide Healing Abutment 6mmD x 4mmL	50	ISF1335	Touareg™-OS Dental Implant 3.5D 13L	33,34
RS3015	RS Wide Healing Abutment 6mmD x 5mmL	50	ISF1635	Touareg™-OS Dental Implant 3.5D 16L	33,34
RS3890	RS Wide Profile Titanium Abutment	51	ISF1835	Touareg™-OS Dental Implant 3.5D 18L	33,34
	S		ISF0835	Touareg™-OS Dental Implant 3.5D 8L	33,34
S1003	Short Drill Stop Kit - Regular	73	ISF1038	Touareg™-OS Dental Implant 3.75D 10L	33,35
S1004	Short Drill Stop Kit - Wide	73	ISF1138	Touareg™-OS Dental Implant 3.75D 11.5L	33,35
RS2675SS	Stainless Steel Ball Cap	15,21,28,53	ISF1338	Touareg™-OS Dental Implant 3.75D 13L	33,35
RP0004	Star Hand Driver - Long	11,16,23,30,63,66,69	ISF1638	Touareg™-OS Dental Implant 3.75D 16L	33,35
RP0064	Star Hand Driver - Short	11,16,23,30,63,66,69	ISF1838	Touareg™-OS Dental Implant 3.75D 18L	33,35
RP0019	Star Handpiece Driver - Long	11,16,23,30,66,69	ISF0838	Touareg™-OS Dental Implant 3.75D 8L	33,35
RP0018	Star Handpiece Driver - Short	11,16,23,30,66,69	ISF1042	Touareg™-OS Dental Implant 4.2D 10L	33,36
RP0005	Star Torque Driver - Long	11,16,23,30,66,69	ISF1142	Touareg™-OS Dental Implant 4.2D 11.5L	33,36
RP0065	Star Torque Driver - Short	11,16,23,30,66,69	ISF1342	Touareg™-OS Dental Implant 4.2D 13L	33,36
RS7001	Surgical Driver	67	ISF1642	Touareg™-OS Dental Implant 4.2D 16L	33,36
RS6111	Surgical Torque Ratchet 35-100 Ncm	63,65,67	ISF1842	Touareg™-OS Dental Implant 4.2D 18L	33,36
ID1033	Swell™ Dental Implant 3.3D 10L	44,45	ISF0642	Touareg™-OS Dental Implant 4.2D 6.25L	33,36
ID1133	Swell™ Dental Implant 3.3D 11.5L	44,45	ISF0842	Touareg™-OS Dental Implant 4.2D 8L	33,36
ID1333	Swell™ Dental Implant 3.3D 13L	44,45	ISF1050	Touareg™-OS Dental Implant 5.0D 10L	33,37
ID1633	Swell™ Dental Implant 3.3D 16L	44,45	ISF1150	Touareg™-OS Dental Implant 5.0D 11.5L	33,37
ID1833	Swell™ Dental Implant 3.3D 18L	44,45	ISF1350	Touareg™-OS Dental Implant 5.0D 13L	33,37
ID1038	Swell™ Dental Implant 3.75D 10L	44,46	ISF1650	Touareg™-OS Dental Implant 5.0D 16L	33,37
ID1138	Swell™ Dental Implant 3.75D 11.5L	44,46	ISF0650	Touareg™-OS Dental Implant 5.0D 6.25L	33,37
ID1338	Swell™ Dental Implant 3.75D 13L	44,46	ISF0850	Touareg™-OS Dental Implant 5.0D 8L	33,37
ID1638	Swell™ Dental Implant 3.75D 16L	44,46	ISF1060	Touareg™-OS Dental Implant 6.0D 10L	33,38
ID1838	Swell™ Dental Implant 3.75D 18L	44,46	ISF1160	Touareg™-OS Dental Implant 6.0D 11.5L	33,38
ID0838	Swell™ Dental Implant 3.75D 8L	44,46	ISF1360	Touareg™-OS Dental Implant 6.0D 13L	33,38
ID1042	Swell™ Dental Implant 4.2D 10L	44,47	ISF0660	Touareg™-OS Dental Implant 6.0D 6.25L	33,38
ID1142	Swell™ Dental Implant 4.2D 11.5L	44,47	ISF0860	Touareg™-OS Dental Implant 6.0D 8L	33,38
ID1342	Swell™ Dental Implant 4.2D 13L	44,47	ISPS1035	Touareg™-S Dental Implant 3.5D 10L	33,39
ID1642	Swell™ Dental Implant 4.2D 16L	44,47	ISPS1135	Touareg™-S Dental Implant 3.5D 11.5L	33,39
ID1842	Swell™ Dental Implant 4.2D 18L	44,47	ISPS1335	Touareg™-S Dental Implant 3.5D 13L	33,39
ID0642	Swell™ Dental Implant 4.2D 6.25L	44,47	ISPS1635	Touareg™-S Dental Implant 3.5D 16L	33,39
ID0842	Swell™ Dental Implant 4.2D 8L	44,47	ISPS1835	Touareg™-S Dental Implant 3.5D 18L	33,39
ID1050	Swell™ Dental Implant 5.0D 10L	44,48	ISPS0835	Touareg™-S Dental Implant 3.5D 8L	33,39
ID1150	Swell™ Dental Implant 5.0D 11.5L	44,48	ISPS1038	Touareg™-S Dental Implant 3.75D 10L	33,40
ID1350	Swell™ Dental Implant 5.0D 13L	44,48	ISPS1138	Touareg™-S Dental Implant 3.75D 11.5L	33,40
ID1650	Swell™ Dental Implant 5.0D 16L	44,48	ISPS1338	Touareg™-S Dental Implant 3.75D 13L	33,40
ID0650	Swell™ Dental Implant 5.0D 6.25L	44,48	ISPS1638	Touareg™-S Dental Implant 3.75D 16L	33,40
ID0850	Swell™ Dental Implant 5.0D 8L	44,48	ISPS1838	Touareg™-S Dental Implant 3.75D 18L	33,40
ID1060	Swell™ Dental Implant 6.0D 10L	44,49	ISPS0838	Touareg™-S Dental Implant 3.75D 8L	33,40
ID1160	Swell™ Dental Implant 6.0D 11.5L	44,49	ISPS1042	Touareg™-S Dental Implant 4.2D 10L	33,41
ID1360	Swell™ Dental Implant 6.0D 13L	44,49	ISPS1142	Touareg™-S Dental Implant 4.2D 11.5L	33,41
ID0660	Swell™ Dental Implant 6.0D 6.25L	44,49	ISPS1342	Touareg™-S Dental Implant 4.2D 13L	33,41
ID0860	Swell™ Dental Implant 6.0D 8L	44,49	ISPS1642	Touareg™-S Dental Implant 4.2D 16L	33,41
	T		ISPS1842	Touareg™-S Dental Implant 4.2D 18L	33,41
TD2218	Three Step Drill - Long	63,65,72	ISPS0642	Touareg™-S Dental Implant 4.2D 6.25L	33,41
TD1511	Three Step Drill - Short	63,65,72	ISPS0842	Touareg™-S Dental Implant 4.2D 8L	33,41
RS8032	Tip Drill	63,65,72	ISPS1050	Touareg™-S Dental Implant 5.0D 10L	33,42
RS2670	Titanium Ball Cap	10,15,21,28,53	ISPS1150	Touareg™-S Dental Implant 5.0D 11.5L	33,42
RS6191	TMA/FC Female Hand Hex Driver-Long	16,23,30,55,66,69,70	ISPS1350	Touareg™-S Dental Implant 5.0D 13L	33,42
RS6193	TMA/FC Female Hand Hex Driver-Short	16,23,30,55,66,69,70	ISPS1650	Touareg™-S Dental Implant 5.0D 16L	33,42
RS6195A	TMA / FC Hex Handpiece Adapter - Long	16,23,30,55,66,69,70	ISPS0650	Touareg™-S Dental Implant 5.0D 6.25L	33,42
RS6194	TMA / FC Hex Handpiece Adapter - Short	16,23,30,55,66,69,70	ISPS0850	Touareg™-S Dental Implant 5.0D 8L	33,42
RS6196	TMA / FC Hex Torque Driver - Long	16,23,30,55,66,69,70	ISPS1060	Touareg™-S Dental Implant 6.0D 10L	33,43
RS6197	TMA / FC Hex Torque Driver - Short	16,23,30,55,66,69,70	ISPS1160	Touareg™-S Dental Implant 6.0D 11.5L	33,43
RS5004	TMA Abutment Replica	14,20,27,52	ISPS1360	Touareg™-S Dental Implant 6.0D 13L	33,43
RS5011	TMA Closed Tray Transfer	14,20,27,52	ISPS0660	Touareg™-S Dental Implant 6.0D 6.25L	33,43
RS5005	TMA Healing Cap	14,20,27,52	ISPS0860	Touareg™-S Dental Implant 6.0D 8L	33,43
RS5006	TMA Open Tray Transfer	14,20,27,52	DL1325	Twist Step Drill 1.8/2.5mmD x 6-13mmL	63,72
			DL1825	Twist Step Drill 1.8/2.5mmD x 8-18mmL	63,72
			DL1328	Twist Step Drill 2.3/2.8mmD x 6-13mmL	63,65,72

Catalog No.	Description	Page No.	Catalog No.	Description	Page No.
WP3403	WP Retaining Screw for Angled TMA	29	WP0012	WP Straight Abutment 1mm	26
WP3406	WP Retaining Screw for TMA 1mm	29	WP0011	WP Straight Abutment 2mm	26
WP3407	WP Retaining Screw for TMA 2mm	29	WP0010	WP Straight Abutment 3mm	26
WP3408	WP Retaining Screw for TMA 3mm	29	WP0020	WP Straight Slim Abutment - No End Line	26
WP3409	WP Retaining Screw for TMA 4mm	29	WP3731	WP Straight Trans Mucosal Abutment 1mm	27
WP3412	WP Retaining Screw for TMA 5mm	29	WP3732	WP Straight Trans Mucosal Abutment 2mm	27
WP3401	WP Retrieval Screw for Abutments	29,66	WP3733	WP Straight Trans Mucosal Abutment 3mm	27
WP5109	WP Slim Closed Tray Transfer 4mmDx9mmL	28	WP3729	WP Straight Trans Mucosal Abutment 4mm	27
WP5113	WP Slim Closed Tray Transfer 4mmDx13mmL	28	WP3730	WP Straight Trans Mucosal Abutment 5mm	27
WP0046	WP Slim Healing Abutment 4mmD x 2mmL	26	WP5309	WP Wide Closed Tray Transfer 6mmDx9mmL	28
WP0047	WP Slim Healing Abutment 4mmD x 3mmL	26	WP5313	WP Wide Closed Tray Transfer 6mmDx13mmL	28
WP0048	WP Slim Healing Abutment 4mmD x 4mmL	26	WP5410	WP Wide Open Tray Transfer 6mmDx10mmL	28
WP0049	WP Slim Healing Abutment 4mmD x 5mmL	26	WP5414	WP Wide Open Tray Transfer 6mmDx14mmL	28
WP0050	WP Slim Healing Abutment 4mmD x 6mmL	26	RS6100	Wrench Ratchet	63,65,67
WP5610	WP Slim Open Tray Transfer 4mmDx10mmL	28	RA0050	Wrench Ratchet Surgical Instruments Handle	11,16,23,30,63,65,67,68,70
WP5614	WP Slim Open Tray Transfer 4mmDx14mmL	28			

Index in Numerical Order

Catalog No.	Description	Page No.	Catalog No.	Description	Page No.
ASD0610	Radiographic Template Touareg™ S/OS	34,35,36,37,38,39,40,41,42,43	ID0650	Swell™ Dental Implant 5.0D 6.25L	44,48
ASD0611	Radiographic Template NP	12	ID0660	Swell™ Dental Implant 6.0D 6.25L	44,49
ASD0612	Radiographic Template RP/WP	18,24,25	ID0838	Swell™ Dental Implant 3.75D 8L	44,46
ASD0613	Radiographic Template Swell	45,46,47,48,49	ID0842	Swell™ Dental Implant 4.2D 8L	44,46
ASD0614	Radiographic Template One	57,58,59,60,61	ID0850	Swell™ Dental Implant 5.0D 8L	44,48
ASD0615	Radiographic Template UNP	8	ID0860	Swell™ Dental Implant 6.0D 8L	44,49
CF6300	CloseFit™ Surgical Kit - Premium	63	ID1033	Swell™ Dental Implant 3.3D 10L	44,45
CF6302	CloseFit™ Surgical Kit - Advanced	63	ID1038	Swell™ Dental Implant 3.75D 10L	44,46
CF6303	CloseFit™ Surgical Kit - Starter	63	ID1042	Swell™ Dental Implant 4.2D 10L	44,47
CF6304	CloseFit™ Surgical Kit-Advanced Short Drills	63	ID1050	Swell™ Dental Implant 5.0D 10L	44,48
CF6305	CloseFit™ Surgical Kit-Starter Short Drills	63	ID1060	Swell™ Dental Implant 6.0D 10L	44,49
DL1320	Pilot Drill 2mmD x 6-13mmL	63,65,72	ID1133	Swell™ Dental Implant 3.3D 11.5L	44,45
DL1325	Twist Step Drill 1.8/2.5mmD x 6-13mmL	63,72	ID1138	Swell™ Dental Implant 3.75D 11.5L	44,46
DL1328	Twist Step Drill 2.3/2.8mmD x 6-13mmL	63,65,72	ID1142	Swell™ Dental Implant 4.2D 11.5L	44,47
DL1332	Twist Step Drill 2.8/3.2mmD x 6-13mmL	63,65,72	ID1150	Swell™ Dental Implant 5.0D 11.5L	44,48
DL1336	Twist Step Drill 3.2/3.6mmD x 6-13mm L	63,65,72	ID1160	Swell™ Dental Implant 6.0D 11.5L	44,49
DL1342	Twist Step Drill 3.8/4.2mmD x 6-13mmL	63,65,72	ID1333	Swell™ Dental Implant 3.3D 13L	44,45
DL1346	Twist Step Drill 4.2/4.6mmD x 6-13mmL	63,65,72	ID1338	Swell™ Dental Implant 3.75D 13L	44,46
DL1352	Twist Step Drill 4.8/5.2mmD x 6-13mmL	65,72	ID1342	Swell™ Dental Implant 4.2D 13L	44,47
DL1356	Twist Step Drill 5.2/5.6mmD x 6-13mmL	65,72	ID1350	Swell™ Dental Implant 5.0D 13L	44,48
DL1820	Pilot Drill 2mmD x 8-18mmL	63,65,67	ID1360	Swell™ Dental Implant 6.0D 13L	44,49
DL1825	Twist Step Drill 1.8/2.5mmD x 8-18mmL	63,72	ID1633	Swell™ Dental Implant 3.3D 16L	44,45
DL1828	Twist Step Drill 2.3/2.8mmD x 8-18mmL	63,65,72	ID1638	Swell™ Dental Implant 3.75D 16L	44,46
DL1832	Twist Step Drill 2.8/3.2mmD x 8-18mmL	63,65,72	ID1642	Swell™ Dental Implant 4.2D 16L	44,47
DL1836	Twist Step Drill 3.2/3.6mmD x 8-18mmL	63,65,72	ID1650	Swell™ Dental Implant 5.0D 16L	44,48
DL1842	Twist Step Drill 3.8/4.2mmD x 8-18mmL	63,65,72	ID1833	Swell™ Dental Implant 3.3D 18L	44,45
DL1846	Twist Step Drill 4.2/4.6mmD x 8-18mmL	63,65,72	ID1838	Swell™ Dental Implant 3.75D 18L	44,46
DL1852	Twist Step Drill 4.8/5.2mmD x 8-18mmL	65,72	ID1842	Swell™ Dental Implant 4.2D 18L	44,47
DL1856	Twist Step Drill 5.2/5.6mmD x 8-18mmL	72	IO1030	One™ Dental Implant 3.3D 10L	56,57
FC4502	Flat Connection Abutment 2mm	52	IO1033	One™ Dental Implant 3.3D 10L	56,58
FC4504	Flat Connection Abutment 4mm	52	IO1036	One™ Dental Implant 3.6D 10L	56,59
FC5512	Flat Connection Transfer	14,20,27,52	IO1042	One™ Dental Implant 4.2D 10L	56,60
FC5515	Flat Connection Temporary Cylinder Sleeve	14,20,27,52	IO1050	One™ Dental Implant 5.0D 10L	56,57
FC5737	Flat Connection Implant Replica	14,20,27,52	IO1130	One™ Dental Implant 3.0D 11.5L	56,57
FC6011	Flat Connection Castable Abutment for Centering Ring	14,20,27,52	IO1133	One™ Dental Implant 3.3D 11.5L	56,58
FC6013	Flat Connection Titanium Gluing Ring	14,20,27,52	IO1136	One™ Dental Implant 3.6D 11.5L	56,59
FC6015	Flat Connection Titanium Retaining Screw	14,20,27,52	IO1142	One™ Dental Implant 4.2D 11.5L	56,60
FC6017	Flat Connection Long Laboratory Screw	14,20,27,52	IO1150	One™ Dental Implant 5.0D 11.5L	56,61
FC6018	Flat Connection Centering Ring	14,20,27,52	IO1330	One™ Dental Implant 3.0D 13L	56,57
HA1000	Osteotome Kit	67	IO1333	One™ Dental Implant 3.3D 13L	56,58
HA0061	Osteotome insert 2.0mmD	67	IO1336	One™ Dental Implant 3.3D 13L	56,59
HA0064	Osteotome insert 2.8mmD	67	IO1342	One™ Dental Implant 4.2D 13L	56,60
HA0067	Osteotome insert 3.25mmD	67	IO1350	One™ Dental Implant 5.0D 13L	56,61
HA0070	Osteotome insert 3.65mmD	67	IO1530	One™ Dental Implant 3.0D 15L	56,57
ID0642	Swell™ Dental Implant 4.2D 6.25L	44,47	IO1533	One™ Dental Implant 3.3D 15L	56,58

Catalog No.	Description	Page No.	Catalog No.	Description	Page No.
IO1536	One™ Dental Implant 3.6D 15L	56,59	ISPUNP1027	UNP Dental Implant 2.75D 10L	7,8
IO1542	One™ Dental Implant 4.2D 15L	56,60	ISPUNP1127	UNP Dental Implant 2.75D 11.5L	7,8
IO1550	One™ Dental Implant 5.0D 15L	56,61	ISPUNP1327	UNP Dental Implant 2.75D 13L	7,8
ISF0642	Touareg™-OS Dental Implant 4.2D 6.25L	33,36	ISPUNP1627	UNP Dental Implant 2.75D 16L	7,8
ISF0650	Touareg™-OS Dental Implant 5.0D 6.25L	33,37	ISPUNP1827	UNP Dental Implant 2.75D 18L	7,8
ISF0660	Touareg™-OS Dental Implant 6.0D 6.25L	33,38	ISPX0835	RP Dental Implant 3.5D 8.0L	7,18
ISF0835	Touareg™-OS Dental Implant 3.5D 8L	33,34	ISPX0843	WP Dental Implant 4.3D 8.0L	7,24
ISF0838	Touareg™-OS Dental Implant 3.75D 8L	33,35	ISPX0849	WP Dental Implant 5D 8.0L	7,25
ISF0842	Touareg™-OS Dental Implant 4.2D 8L	33,36	ISPX1035	RP Dental Implant 3.5D 10L	7,18
ISF0850	Touareg™-OS Dental Implant 5.0D 8L	33,37	ISPX1043	WP Dental Implant 4.3D 10L	7,24
ISF0860	Touareg™-OS Dental Implant 6.0D 8L	33,38	ISPX1049	WP Dental Implant 5D 10L	7,25
ISF1035	Touareg™-OS Dental Implant 3.5D 10L	33,34	ISPX1135	RP Dental Implant 3.5D 11.5L	7,18
ISF1038	Touareg™-OS Dental Implant 3.75D 10L	33,35	ISPX1143	WP Dental Implant 4.3D 11.5L	7,24
ISF1042	Touareg™-OS Dental Implant 4.2D 10L	33,36	ISPX1149	WP Dental Implant 5D 11.5L	7,25
ISF1050	Touareg™-OS Dental Implant 5.0D 10L	33,37	ISPX1335	RP Dental Implant 3.5D 13L	7,18
ISF1060	Touareg™-OS Dental Implant 6.0D 10L	33,38	ISPX1343	WP Dental Implant 4.3D 13L	7,24
ISF1135	Touareg™-OS Dental Implant 3.5D 11.5L	33,34	ISPX1349	WP Dental Implant 5D 13L	7,25
ISF1138	Touareg™-OS Dental Implant 3.75D 11.5L	33,35	ISPX1535	RP Dental Implant 3.5D 15L	7,18
ISF1142	Touareg™-OS Dental Implant 4.2D 11.5L	33,36	ISPX1543	WP Dental Implant 4.3D 15L	7,24
ISF1150	Touareg™-OS Dental Implant 5.0D 11.5L	33,37	ISPX1549	WP Dental Implant 5D 15L	7,25
ISF1160	Touareg™-OS Dental Implant 6.0D 11.5L	33,38	ISPX1835	RP Dental Implant 3.5D 18L	7,18
ISF1335	Touareg™-OS Dental Implant 3.5D 13L	33,34	ISPX1843	WP Dental Implant 4.3D 18L	7,24
ISF1338	Touareg™-OS Dental Implant 3.75D 13L	33,35	ISPX1849	WP Dental Implant 5D 18L	7,25
ISF1342	Touareg™-OS Dental Implant 4.2D 13L	33,36	NP0001	NP Abutment Screw	15
ISF1350	Touareg™-OS Dental Implant 5.0D 13L	33,37	NP0004	NP Healing Abutment 4.5mmD x 2mmL	13
ISF1360	Touareg™-OS Dental Implant 6.0D 13L	33,38	NP0005	NP 2mm Torque Driver - Long	16,68
ISF1635	Touareg™-OS Dental Implant 3.5D 16L	33,34	NP0006	NP 2mm Torque Driver - Short	16,68
ISF1638	Touareg™-OS Dental Implant 3.75D 16L	33,35	NP0007	NP Implant Analog	15
ISF1642	Touareg™-OS Dental Implant 4.2D 16L	33,36	NP0008	NP Healing Abutment 4.5mmD x 3mmL	13
ISF1650	Touareg™-OS Dental Implant 5.0D 16L	33,37	NP0009	NP Healing Abutment 4.5mmD x 4mmL	13
ISF1835	Touareg™-OS Dental Implant 3.5D 18L	33,34	NP0010	NP Straight Slim Abutment - No End Line	13
ISF1838	Touareg™-OS Dental Implant 3.75D 18L	33,35	NP0011	NP Straight Abutment 2mm	13
ISF1842	Touareg™-OS Dental Implant 4.2D 18L	33,36	NP0012	NP Healing Abutment 4.5mmD x 5mmL	13
ISPNP1030	NP Dental Implant 3.0D 10L	7,12	NP0013	NP Healing Abutment 4.5mmD x 6mmL	13
ISPNP1130	NP Dental Implant 3.0D 11.5L	7,12	NP0014	NP Retrieval Screw for Abutments	15,16,66
ISPNP1330	NP Dental Implant 3.0D 13L	7,12	NP0015	NP Angled Abutment 15° 1mm	13
ISPNP1630	NP Dental Implant 3.0D 16L	7,12	NP0018	NP Angled Abutment 15° - No End Line	13
ISPNP1830	NP Dental Implant 3.0D 18L	7,12	NP0019	NP Straight Abutment 1mm	13
ISPS0642	Touareg™-S Dental Implant 4.2D 6.25L	33,41	NP0020	NP Ball Attachment 0.5mm	15
ISPS0650	Touareg™-S Dental Implant 5.0D 6.25L	33,42	NP0021	NP Ball Attachment 1mm	15
ISPS0660	Touareg™-S Dental Implant 6.0D 6.25L	33,43	NP0022	NP Ball Attachment 2mm	15
ISPS0835	Touareg™-S Dental Implant 3.5D 8L	33,39	NP0023	NP Ball Attachment 3mm	15
ISPS0838	Touareg™-S Dental Implant 3.75D 8L	33,40	NP0024	NP Ball Attachment 4mm	15
ISPS0842	Touareg™-S Dental Implant 4.2D 8L	33,41	NP0025	NP Angled Abutment 25° - No End Line	13
ISPS0850	Touareg™-S Dental Implant 5.0D 8L	33,42	NP0026	NP Angled Abutment 15° 2mm	13
ISPS0860	Touareg™-S Dental Implant 6.0D 8L	33,43	NP0030	NP Flat Connection Abutment 2mm	14
ISPS1035	Touareg™-S Dental Implant 3.5D 10L	33,39	NP0031	NP Flat Connection Abutment 4mm	14
ISPS1038	Touareg™-S Dental Implant 3.75D 10L	33,40	NP0032	NP Straight Trans Mucosal Abutment 1mm	14
ISPS1042	Touareg™-S Dental Implant 4.2D 10L	33,41	NP0033	NP Straight Trans Mucosal Abutment 2mm	14
ISPS1050	Touareg™-S Dental Implant 5.0D 10L	33,42	NP0034	NP Straight Trans Mucosal Abutment 3mm	14
ISPS1060	Touareg™-S Dental Implant 6.0D 10L	33,43	NP0035	NP Angled Trans Mucosal Abutment 17° L=3mm	14
ISPS1135	Touareg™-S Dental Implant 3.5D 11.5L	33,39	NP0036	NP Angled Trans Mucosal Abutment 30° L=3.5mm	14
ISPS1138	Touareg™-S Dental Implant 3.75D 11.5L	33,40	NP0037	NP Angled Trans Mucosal Abutment 30° L=5mm	14
ISPS1142	Touareg™-S Dental Implant 4.2D 11.5L	33,41	NP0038	NP Angled Trans Mucosal Abutment 17° L=4mm	14
ISPS1150	Touareg™-S Dental Implant 5.0D 11.5L	33,42	NP0039	NP Retaining Screw for TMA 1mm	15
ISPS1160	Touareg™-S Dental Implant 6.0D 11.5L	33,43	NP0040	NP Retaining Screw for TMA 2mm	15
ISPS1335	Touareg™-S Dental Implant 3.5D 13L	33,39	NP0041	NP Retaining Screw for TMA 3mm	15
ISPS1338	Touareg™-S Dental Implant 3.75D 13L	33,40	NP0042	NP Retaining Screw for Angled TMA	15
ISPS1342	Touareg™-S Dental Implant 4.2D 13L	33,41	NP0043	NP Engaging Temporary Abutment	13
ISPS1350	Touareg™-S Dental Implant 5.0D 13L	33,42	NP0044	NP Non Engaging Temporary Abutment	13
ISPS1360	Touareg™-S Dental Implant 6.0D 13L	33,43	NP0045	NP Plastic Cylinder Abutment	13
ISPS1635	Touareg™-S Dental Implant 3.5D 16L	33,39	NP0046	NP Slim Healing Abutment 3mmD x 2mmL	13
ISPS1638	Touareg™-S Dental Implant 3.75D 16L	33,40	NP0047	NP Slim Healing Abutment 3mmD x 3mmL	13
ISPS1642	Touareg™-S Dental Implant 4.2D 16L	33,41	NP0048	NP Slim Healing Abutment 3mmD x 4mmL	13
ISPS1650	Touareg™-S Dental Implant 5.0D 16L	33,42	NP0049	NP Slim Healing Abutment 3mmD x 5mmL	13
ISPS1835	Touareg™-S Dental Implant 3.5D 18L	33,39	NP0050	NP Slim Healing Abutment 3mmD x 6mmL	13
ISPS1838	Touareg™-S Dental Implant 3.75D 18L	33,40	NP0062	NP 2mm Hex Handpiece Adapter - Short 20mm	16,68
ISPS1842	Touareg™-S Dental Implant 4.2D 18L	33,41	NP0063	NP Angled Abutment 15° 3mm	13

Catalog No.	Description	Page No.	Catalog No.	Description	Page No.
NP0064	NP Straight Abutment 3mm	13	RP0065	Star Torque Driver - Short	11,16,23,30,66,69
NP0068	NP 2mm Hex Handpiece Adapter - Short 24mm	16,63,68	RP0066	RP 2.2mm Torque Driver - Long	23,68
NP0071	NP 2mm Hex Handpiece Adapter - Medium 28mm	16,63,68	RP0067	RP 2.2mm Torque Driver - Short	23,68
NP0072	NP 2mm Hex Handpiece Adapter - Long 25mm	16,68	RP0068	RP 2.25mm Hex Handpiece Adapter - Short	23,63,68
NP0073	NP Conical Implant Cover Screw	13,15	RP0071	RP 2.25mm Hex Handpiece Adapter - Medium	23,63,68
NP0074	NP 2mm Hex Handpiece Adapter - Long 36mm	16,63,68	RP0072	RP Handpiece Hex Adapter - Long	23,68
NP0090	NP Conical Healing Abutment 4.5mmD x 2mmL	13	RP0073	RP Conical Implant Cover Screw	19,22
NP0091	NP Conical Healing Abutment 4.5mmD x 3mmL	13	RP0074	RP 2.25mm Hex Handpiece Adapter - Long	23,63,68
NP0092	NP Conical Healing Abutment 4.5mmD x 4mmL	13	RP0090	RP Conical Healing Abutment 4.5mmD x 2mmL	19
NP0093	NP Conical Healing Abutment 4.5mmD x 5mmL	13	RP0091	RP Conical Healing Abutment 4.5mmD x 3mmL	19
NP0094	NP Conical Healing Abutment 4.5mmD x 6mmL	13	RP0092	RP Conical Healing Abutment 4.5mmD x 4mmL	19
NP3095	NP Engaging Titanium / Plastic Abutment	14	RP0093	RP Conical Healing Abutment 4.5mmD x 5mmL	19
NP3097	NP Non-Engaging Titanium / Plastic Abutment	14	RP0094	RP Conical Healing Abutment 4.5mmD x 6mmL	19
NP3409	NP Retaining Screw for TMA 4mm	15	RP3095	RP Engaging Titanium / Plastic Abutment	19
NP3412	NP Retaining Screw for TMA 5mm	15	RP3097	RP Non-Engaging Titanium / Plastic Abutment	19
NP3729	NP Straight Trans Mucosal Abutment 4mm	14	RP3401	RP Retrieval Screw for Abutments	21,66
NP3730	NP Straight Trans Mucosal Abutment 5mm	14	RP3403	RP Retaining Screw for Angled TMA	22
NP5014	NP Open Tray Transfer Screw	15	RP3409	RP Retaining Screw for TMA 4mm	22
NP5113	NP Slim Closed Tray Transfer 3.2mmDx13mmL	15	RP3412	RP Retaining Screw for TMA 5mm	22
NP5127	NP Closed Tray Transfer Screw	15	RP3729	RP Straight Trans Mucosal Abutment 4 mm	20
NP5213	NP Closed Tray Transfer 4.2mmDx13mmL	15	RP3730	RP Straight Trans Mucosal Abutment 5 mm	20
NP5514	NP Open Tray Transfer 4.2mmDx14mmL	15	RP3734	RP Angled Trans Mucosal Abutment 17° 2.5mm	20
NP5614	NP Slim Open Tray Transfer 3.2mmDx14mmL	15	RP3735	RP Angled Trans Mucosal Abutment 30° 3mm	20
PK6300	Prosthetic Kit Metal	66	RP3737	RP Angled Trans Mucosal Abutment 17° 3.5mm	20
RA0050	Wrench Ratchet Surgical Instruments Handle	11,16,23,30,63,65,67,68,70	RP3738	RP Angled Trans Mucosal Abutment 30° 4mm	20
RP0001	RP Abutment Screw	22	RP5010	RP Open Tray Transfer Screw - Short	22
RP0004	Star Hand Driver - Long	11,16,23,30,63,66,69	RP5014	RP Open Tray Transfer Screw - Long	22
RP0005	Star Torque Driver - Long	11,16,23,30,66,69	RP5109	RP Slim Closed Tray Transfer 3.6mmDx9mmL	21
RP0007	RP Implant Analog	21	RP5113	RP Slim Closed Tray Transfer 3.6mmDx13mmL	21
RP0010	RP Straight Abutment 3mm	19	RP5126	RP Closed Tray Transfer Screw - Short	22
RP0011	RP Straight Abutment 2mm	19	RP5127	RP Closed Tray Transfer Screw - Long	22
RP0012	RP Straight Abutment 1mm	19	RP5209	RP Closed Tray Transfer 4.2mmDx9mmL	21
RP0013	RP Angled Abutment 15° 1mm	19	RP5213	RP Closed Tray Transfer 4.2mmDx13mmL	21
RP0014	RP Angled Abutment 15° 2mm	19	RP5510	RP Open Tray Transfer 4.2mmDx10mmL	21
RP0015	RP Angled Abutment 15° 3mm	19	RP5514	RP Open Tray Transfer 4.2mmDx14mmL	21
RP0018	Star Handpiece Driver - Short	11,16,23,30,66,69	RP5610	RP Slim Open Tray Transfer 3.6mmDx10mmL	21
RP0019	Star Handpiece Driver - Long	11,16,23,30,66,69	RP5614	RP Slim Open Tray Transfer 3.6mmDx14mmL	21
RP0020	RP Straight Slim Abutment - No End Line	19	RS0010	RS Esthetic Straight Abutment 1mmL	50
RP0022	RP Healing Abutment 4.5mmD x 2mmL	19	RS0011	RS Esthetic Straight Abutment 2mmL	50
RP0023	RP Healing Abutment 4.5mmD x 3mmL	19	RS0012	RS Esthetic Straight Abutment 3mmL	50
RP0024	RP Healing Abutment 4.5mmD x 4mmL	19	RS2660	Plastic Ball Cap White	10,15,21,28,53
RP0025	RP Healing Abutment 4.5mmD x 5mmL	19	RS2662	Plastic Ball Cap Pink Soft	10,15,21,28,53
RP0026	RP Healing Abutment 4.5mmD x 6mmL	19	RS2670	Titanium Ball Cap	10,15,21,28,53
RP0030	RP Flat Connection Abutment 2mm	20	RS2675SS	Stainless Steel Ball Cap	15,21,28,53
RP0031	RP Flat Connection Abutment 4mm	20	RS2861	RS Ball Attachment 1mm w/Hex	52
RP0032	RP Straight Trans Mucosal Abutment 1mm	20	RS2862	RS Ball Attachment 2mm w/Hex	52
RP0033	RP Straight Trans Mucosal Abutment 2mm	20	RS2863	RS Ball Attachment 3mm w/Hex	52
RP0034	RP Straight Trans Mucosal Abutment 3mm	20	RS2864	RS Ball Attachment 4mm w/Hex	52
RP0039	RP Retaining Screw For TMA 1mm	22	RS2865	RS Ball Attachment 5mm w/Hex	52
RP0040	RP Retaining Screw For TMA 2mm	22	RS2866	RS Ball Attachment 6mm w/Hex	53
RP0041	RP Retaining Screw For TMA 3mm	22	RS3012	RS Wide Healing Abutment 6mmD x 2mmL	50
RP0043	RP Engaging Temporary Abutment	19	RS3013	RS Wide Healing Abutment 6mmD x 3mmL	50
RP0044	RP Non-Engaging Temporary Abutment	19	RS3014	RS Wide Healing Abutment 6mmD x 4mmL	50
RP0045	RP Engaging Plastic Cylinder Abutment	19	RS3015	RS Wide Healing Abutment 6mmD x 5mmL	50
RP0046	RP Slim Healing Abutment 3.5mmD x 2mmL	19	RS3022	RS Healing Abutment 4.5mmD x 2mmL	50
RP0047	RP Slim Healing Abutment 3.5mmD x 3mmL	19	RS3023	RS Healing Abutment 4.5mmD x 3mmL	50
RP0048	RP Slim Healing Abutment 3.5mmD x 4mmL	19	RS3024	RS Healing Abutment 4.5mmD x 4mmL	50
RP0049	RP Slim Healing Abutment 3.5mmD x 5mmL	19	RS3025	RS Healing Abutment 4.5mmD x 5mmL	50
RP0050	RP Slim Healing Abutment 3.5mmD x 6mmL	19,63	RS3026	RS Healing Abutment 4.5mmD x 6mmL	50
RP0051	RP Ball Attachment 0.5mm	21	RS3027	RS Slim Healing Abutment 3.5mmD x 2mmL	50
RP0052	RP Ball Attachment 1mm	21	RS3028	RS Slim Healing Abutment 3.5mmD x 3mmL	50
RP0053	RP Ball Attachment 2mm	21	RS3029	RS Slim Healing Abutment 3.5mmD x 4mmL	50
RP0054	RP Ball Attachment 3mm	21	RS3030	RS Slim Healing Abutment 3.5mmD x 5mmL	50
RP0055	RP Ball Attachment 4mm	21	RS3031	RS Slim Healing Abutment 3.5mmD x 6mmL	50
RP0056	RP Ball Attachment 5mm	21	RS3090	RS Engaging Gold / Plastic Abutment	51
RP0062	RP Handpiece Hex Adapter - Short	23,68	RS3095	RS Engaging Titanium / Plastic Abutment	51
RP0064	Star Hand Driver - Short	11,16,23,30,63,66,69	RS3097	RS Non-Engaging Titanium / Plastic Abutment	51

Catalog No.	Description	Page No.	Catalog No.	Description	Page No.
RS3400	RS Prosthetic Screw	53	RS5127	RS Closed Tray Transfer Screw Long	54
RS3401	RS Retrieval Screw For Abutments	53,66	RS5209	RS Closed Tray Transfer 4.5mmDx9mmL	53
RS3402	RS Short Prosthetic Screw	53	RS5213	RS Closed Tray Transfer 4.5mmDx13mmL	53
RS3403	RS Retaining Screw For Angled TMA	53	RS5737	RS Internal Hex Implant Analog	53
RS3404	TMA Prosthetic Screw	53	RS5740	Ball Attachment Abutment Replica	15,21,28,53
RS3406	RS Retaining Screw for TMA 1mm	54	RS6011	RS 2.4 Hex Torque Driver - Short	55,70
RS3407	RS Retaining Screw for TMA 2mm	54	RS6012	RS 2.4 Hex Torque Driver - Long	55,70
RS3408	RS Retaining Screw for TMA 3mm	54	RS6025	RS One Piece Torque Driver - Short	56,70
RS3409	RS Retaining Screw for TMA 4mm	54	RS6026	RS One Piece Torque Driver - Long	56,70
RS3411	RS Engaging Straight Cylindrical Titanium Abutment 2mm	51	RS6080	1.27 Hex Torque Driver - Short	55,66,70
RS3412	RS Retaining Screw for TMA 5mm	54	RS6082	1.27 Hex Torque Driver - Long	55,66,70
RS3422	RS Non-Engaging Straight Cylindrical Titanium Abutment 2mm	51	RS6090	Torque Driver for Ball Attachment	16,23,30,55,66,69,70
RS3435	RS Implant Cover Screw	50,53	RS6094	1.27 Hex Hand Driver - Medium	55,65,66,70
RS3480	RS Screw for Angled Titanium Abutment	53	RS6095	1.27 Hex Hand Driver - Short	55,65,66,70
RS3510	RS Open Tray Slim Transfer 3.6mmDx10mmL	53	RS6097	1.27 Hex Hand Driver - Long	55,70
RS3514	RS Open Tray Slim Transfer 3.6mmDx14mmL	53	RS6100	Wrench Ratchet	63,65,67
RS3729	RS Straight Trans Mucosal Abutment 4 mm	51	RS6111	Surgical Torque Ratchet 35-100 Ncm	63,65,67
RS3730	RS Straight Trans Mucosal Abutment 5 mm	52	RS6112	Prosthetic Torque Ratchet 15-35 Ncm	66,67
RS3731	RS Straight Trans Mucosal Abutment 1mm	51	RS6150	Parallel Pin 11	63,65,67
RS3732	RS Straight Trans Mucosal Abutment 2mm	51	RS6155	Parallel Pin 16	63,65,67
RS3733	RS Straight Trans Mucosal Abutment 3mm	51	RS6180	Depth Probe	63,65,67
RS3734	RS Angled Trans Mucosal Abutment 17° 2mm	52	RS6191	TMA/FC Female Hand Hex Driver-Long	16,23,30,55,66,69,70
RS3735	RS Angled Trans Mucosal Abutment 30° 3mm	52	RS6193	TMA/FC Female Hand Hex Driver-Short	16,23,30,55,66,69,70
RS3736	RS Angled Trans Mucosal Abutment 45° 4mm	52	RS6194	TMA / FC Hex Handpiece Adapter - Short	16,23,30,55,66,69,70
RS3737	RS Angled Trans Mucosal Abutment 17° 3mm	52	RS6195A	TMA / FC Hex Handpiece Adapter - Long	16,23,30,55,66,69,70
RS3738	RS Angled Trans Mucosal Abutment 30° 4mm	52	RS6196	TMA / FC Hex Torque Driver - Long	16,23,30,55,66,69,70
RS3800	RS Straight Titanium Abutment - No End Line	50	RS6197	TMA / FC Hex Torque Driver - Short	16,23,30,55,66,69,70
RS3801	RS Straight Titanium Abutment 1mm	50	RS6301	RS Standard Internal Hex Plastic Surgical Kit - Premium	65
RS3802	RS Straight Titanium Abutment 2mm	50	RS6322	RS Standard Internal Hex Plastic Surgical Kit - Advanced	65
RS3803	RS Straight Titanium Abutment 3mm	50	RS6324	RS Standard Internal Hex Surgical Kit - Advanced Short Drills	65
RS3804	RS Straight Titanium Abutment 4mm	50	RS6333	RS Standard Internal Hex Plastic Surgical Kit - Starter	65
RS3805	RS Straight Titanium Abutment 5 mm	50	RS6334	RS Standard Internal Hex Surgical Kit - Starter Short Drills	65
RS3811	RS Straight Titanium Abutment Long 12.5mm	50	RS7001	Surgical Driver	67
RS3812	RS One Piece Screw-In Abutment	51	RS8032	Tip Drill	63,65,72
RS3890	RS Wide Profile Titanium Abutment	51	RS9020	RS Hex Handpiece Adapter - Short 20mm	55,70
RS3903	RS Slim Titanium Abutment 3mm	50	RS9021	RS Hex Handpiece Adapter - Short 24mm	55,65,70
RS3906	RS Slim Titanium Abutment 6mm	50	RS9025	RS Hex Handpiece Adapter - Long 25mm	55,70
RS3908	RS Slim Titanium Abutment 8mm	50	RS9026	RS Hex Handpiece Adapter - Medium 29mm	55,65,70
RS3950	RS Titanium Abutment 5.0 mmD Wide	51	RS9027	Drill Extension	63,65,72
RS4015	RS Angled Titanium Abutment 15°	51	RS9029	RS Hex Handpiece Adapter - Long 36mm	55,65,70
RS4016	RS Angled Titanium Abutment 15° Long	51	RS9030	1.27 Hex Driver for Handpiece - Short	55,66,70,74
RS4017	RS Slim Angled Abutment 15° 1mm - No End Line	51	RS9035	1.27 Hex Driver for Handpiece - Long	55,66,70,74
RS4018	RS Slim Angled Abutment 15° 2mm - No End Line	51	S1001	Long Drill Stop Kit - Regular	73
RS4019	RS Slim Angled Abutment 15° 3mm - No End Line	51	S1002	Long Drill Stop Kit - Wide	73
RS4025	RS Angled Titanium Abutment 25°	51	S1003	Short Drill Stop Kit - Reangular	73
RS4035	RS Angled Titanium Abutment 35°	51	S1004	Short Drill Stop Kit - Wide	73
RS4115	RS Esthetic Angled Titanium Abutment 15° 1mm	51	S1320L6	Drill Stop for Short L6 1320	73
RS4117	RS Esthetic Angled Titanium Abutment 15° 2mm	51	S1320L11.5	Drill Stop for Short L11.5 1320	73
RS4119	RS Esthetic Angled Titanium Abutment 15° 3mm	51	S1328L6	Drill Stop for Short L6 1328	73
RS4510	RS Open Tray Transfer 4.5mmDx10mmL	53	S1328L11.5	Drill Stop for Short L11.5 1328	73
RS4514	RS Open Tray Transfer 4.5mmDx14mmL	53	S1332L6	Drill Stop for Short L6 1332	73
RS4900	TMA Titanium Temporary Cylinder	14,20,27,52	S1332L11.5	Drill Stop for Short L11.5 1332	73
RS5000	RS Engaging Plastic Cylinder Casting Abutment	51	S1336L6	Drill Stop for Short L6 1336	73
RS5001	TMA Plastic Casting Sleeve w/Prosthetic Screw	14,20,27,52	S1336L11.5	Drill Stop for Short L11.5 1336	73
RS5004	TMA Abutment Replica	14,20,27,52	S1342L6	Drill Stop for Short L6 1342	73
RS5005	TMA Healing Cap	14,20,27,52	S1342L11.5	Drill Stop for Short L11.5 1342	73
RS5006	TMA Open Tray Transfer	14,20,27,52	S1346L6	Drill Stop for Short L6 1346	73
RS5008	TMA Screw For Open Tray Impression Copying	54	S1346L11.5	Drill Stop for Short L11.5 1346	73
RS5010	RS Engaging Plastic Casting Standard Abutment	51	S1352L6	Drill Stop for Short L6 1352	73
RS5011	TMA Closed Tray Transfer	14,20,27,52	S1352L11.5	Drill Stop for Short L11.5 1352	73
RS5020	RS Non-Engaging Plastic Cylinder Casting Abutment	51	S1356L6	Drill Stop for Short L6 1356	73
RS5030	RS Engaging Plastic Standard Abutment	51	S1356L11.5	Drill Stop for Short L11.5 1356	73
RS5040	RS Engaging Plastic Cylinder Abutment	51	S1820L10	Drill Stop for Long L10 1820	73
RS5050	RS Non-Engaging Plastic Standard Abutment	51	S1820L11.5	Drill Stop for Long L11.5 1820	73
RS5109	RS Slim Closed Tray Transfer 3.5mmDx9mmL	53	S1820L13	Drill Stop for Long L13/Short L8 1820	73
RS5113	RS Slim Closed Tray Transfer 3.5mmDx13mmL	53	S1820L15	Drill Stop for Long L15/Short L10 1820	73
RS5126	RS Closed Tray Transfer Screw Short	54	S1820L16	Drill Stop for Long L16 1820	73

Catalog No.	Description	Page No.	Catalog No.	Description	Page No.
S1820L6	Drill Stop for Long L6 1820	73	UNP0022	UNP Ball Attachment 2mm	10
S1820L8	Drill Stop for Long L8 1820	73	UNP0023	UNP Ball Attachment 3mm	10
S1828L10	Drill Stop for Long L10 1828	73	UNP0024	UNP Ball Attachment 4mm	10
S1828L11.5	Drill Stop for Long L11.5 1828	73	UNP0025	UNP Ball Attachment 5mm	10
S1828L13	Drill Stop for Long L13/Short L8 1828	73	UNP0026	UNP Angled Abutment 15° 3mm	9
S1828L15	Drill Stop for Long L15/Short L10 1828	73	UNP0043	UNP Engaging Temporary Abutment	9
S1828L16	Drill Stop for Long L16 1828	73	UNP0044	UNP Non Engaging Temporary Abutment	9
S1828L6	Drill Stop for Long L6 1828	73	UNP0045	UNP Engaging Plastic Cylinder Abutment	9
S1828L8	Drill Stop for Long L8 1828	73	UNP0046	UNP Slim Healing Abutment 2.75mmDX2mmL	9
S1832L6	Drill Stop for LongL6 1832	73	UNP0047	UNP Slim Healing Abutment 2.75mmDX3mmL	9
S1832L8	Drill Stop for LongL8 1832	73	UNP0048	UNP Slim Healing Abutment 2.75mmDX4mmL	9
S1832L10	Drill Stop for Long L10 1832	73	UNP0049	UNP Slim Healing Abutment 2.75mmDX5mmL	9
S1832L11.5	Drill Stop for Long L11.5 1832	73	UNP0050	UNP Slim Healing Abutment 2.75mmDX6mmL	9
S1832L13	Drill Stop for Long L13/Short L8 1832	73	UNP0063	UNP Angled Abutment 15° 1mm	9
S1832L15	Drill Stop for Long L15/Short L10 1832	73	UNP0064	UNP Straight Abutment - 3mm	9
S1832L16	Drill Stop for Long L16 1832	73	UNP0068	UNP 2mm Hex Handpiece Adapter - Short	11,63,68
S1836L6	Drill Stop for Long L6 1836	73	UNP0071	UNP 2mm Hex Handpiece Adapter - Medium	11,63,68
S1836L8	Drill Stop for Long L8 1836	73	UNP0073	UNP Conical Cover Screw	9,10
S1836L10	Drill Stop for Long L10 1836	73	UNP0074	UNP 2mm Hex Handpiece Adapter - Long	11,63,68
S1836L11.5	Drill Stop for Long L11.5 1836	73	UNP0080	UNP Esthetic Abutment 1mm	9
S1836L13	Drill Stop for Long L13/Short L8 1836	73	UNP0081	UNP Esthetic Abutment 2mm	9
S1836L15	Drill Stop for Long L15/Short L10 1836	73	UNP0082	UNP Esthetic Abutment 3mm	9
S1836L16	Drill Stop for Long L16 1836	73	UNP0090	UNP Conical Healing Abutment 4mmDX2mmL	9
S1842L6	Drill Stop for Long L6 1842	73	UNP0091	UNP Conical Healing Abutment 4mmDX3mmL	9
S1842L8	Drill Stop for Long L8 1842	73	UNP0092	UNP Conical Healing Abutment 4mmDX4mmL	9
S1842L10	Drill Stop for Long L10 1842	73	UNP0093	UNP Conical Healing Abutment 4mmDX5mmL	9
S1842L11.5	Drill Stop for Long L11.5 1842	73	UNP0094	UNP Conical Healing Abutment 4mmDX6mmL	9
S1842L13	Drill Stop for Long L13/Short L8 1842	73	UNP1001	UNP/NP Abutment Insertion Tool	11,17,69
S1842L15	Drill Stop for Long L15/Short L10 1842	73	UNP3812	UNP One Piece Screw-In Abutment 1mm	10
S1842L16	Drill Stop for Long L16 1842	73	UNP3813	UNP One Piece Screw-In Abutment 2mm	10
S1846L6	Drill Stop for Long L6 1846	73	UNP3814	UNP One Piece Screw-In Abutment 3mm	10
S1846L8	Drill Stop for Long L8 1846	73	UNP5014	UNP Open Tray Transfer Screw	10
S1846L10	Drill Stop for Long L10 1846	73	UNP5113	UNP Slim Closed Tray Transfer 3.2mmDx13mmL	10
S1846L11.5	Drill Stop for Long L11.5 1846	73	UNP5127	UNP Closed Tray Transfer Screw	10
S1846L13	Drill Stop for Long L13/Short L8 1846	73	UNP5213	UNP Closed Tray Transfer 4.0mmDx13mmL	10
S1846L15	Drill Stop for Long L15/Short L10 1846	73	UNP5514	UNP Open Tray Transfer 4mmDx14mmL	10
S1846L16	Drill Stop for Long L16 1846	73	UNP5614	UNP Slim Open Tray Transfer 3.2mmDx14mmL	10
S1852L6	Drill Stop for Long L6 1852	73	UNP6301	UNP Starter Surgical Package	63
S1852L8	Drill Stop for Long L8 1852	73	WP0001	WP Abutment Screw	28
S1852L10	Drill Stop for Long L10 1852	73	WP0007	WP Implant Analog	28
S1852L11.5	Drill Stop for Long L11.5 1852	73	WP0010	WP Straight Abutment 3mm	26
S1852L13	Drill Stop for Long L13/Short L8 1852	73	WP0011	WP Straight Abutment 2mm	26
S1852L15	Drill Stop for Long L15/Short L10 1852	73	WP0012	WP Straight Abutment 1mm	26
S1852L16	Drill Stop for Long L16 1852	73	WP0013	WP Angled Abutment 15° 1mm	26
S1856L6	Drill Stop for Long L6 1856	73	WP0014	WP Angled Abutment 15° 2mm	26
S1856L8	Drill Stop for Long L8 1856	73	WP0015	WP Angled Abutment 15° 3mm	26
S1856L10	Drill Stop for Long L10 1856	73	WP0020	WP Straight Slim Abutment - No End Line	26
S1856L11.5	Drill Stop for Long L11.5 1856	73	WP0022	WP Healing Abutment 5.5mmD x 2mmL	26
S1856L13	Drill Stop for Long L13/Short L8 1856	73	WP0023	WP Healing Abutment 5.5mmD x 3mmL	26
S1856L15	Drill Stop for Long L15/Short L10 1856	73	WP0024	WP Healing Abutment 5.5mmD x 4mmL	26
S1856L16	Drill Stop for Long L16 1856	73	WP0025	WP Healing Abutment 5.5mmD x 5mmL	26
TD1511	Three Step Drill - Short	63,65,72	WP0026	WP Healing Abutment 5.5mmD x 6mmL	26
TD2218	Three Step Drill - Long	63,65,72	WP0030	WP Flat Connection Abutment 2mm	27
UNP0001	UNP Abutment Screw	10	WP0031	WP Flat Connection Abutment 4mm	27
UNP0004	UNP Healing Abutment 4mmDX2mmL	9	WP0043	WP Engaging Temporary Abutment	26
UNP0007	UNP Implant Analog	10	WP0044	WP Non-Engaging Temporary Abutment	26
UNP0008	UNP Healing Abutment 4mmDX3mmL	9	WP0045	WP Engaging Plastic Cylinder Abutment	26
UNP0009	UNP Healing Abutment 4mmDX4mmL	9	WP0046	WP Slim Healing Abutment 4mmD x 2mmL	26
UNP0010	UNP Straight Slim Abutment - No End Line	9	WP0047	WP Slim Healing Abutment 4mmD x 3mmL	26
UNP0011	UNP Straight Abutment - 2mm	9	WP0048	WP Slim Healing Abutment 4mmD x 4mmL	26
UNP0012	UNP Healing Abutment 4mmDX5mmL	9	WP0049	WP Slim Healing Abutment 4mmD x 5mmL	26
UNP0013	UNP Healing Abutment 4mmDX6mmL	9	WP0050	WP Slim Healing Abutment 4mmD x 6mmL	26
UNP0015	UNP Angled Abutment 15° 2mm	9	WP0051	WP Ball Attachment 0.5mm	28
UNP0018	UNP Angled Abutment 15° - No End Line	9	WP0052	WP Ball Attachment 1mm	28
UNP0019	UNP Straight Abutment - 1mm	9	WP0053	WP Ball Attachment 2mm	28
UNP0020	UNP Ball Attachment 0.5mm	10	WP0054	WP Ball Attachment 3mm	28
UNP0021	UNP Ball Attachment 1mm	10	WP0055	WP Ball Attachment 4mm	28

Catalog No.	Description	Page No.
WP0056	WP Ball Attachment 5mm	28
WP0062	WP Handpiece Hex Adapter - Short	30,68
WP0066	WP 2.6mm Torque Driver - Long	30,68
WP0067	WP 2.6mm Torque Driver - Short	30,68
WP0068	WP 2.65mm Hex Handpiece Adapter - Short	30,63,68
WP0071	WP 2.65mm Hex Handpiece Adapter - Medium	30,63,68
WP0072	WP Handpiece Hex Adapter - Long	30,68
WP0073	WP Conical Implant Cover Screw	26,29
WP0074	WP 2.65mm Hex Handpiece Adapter - Long	30,63,68
WP0090	WP Conical Healing Abutment 5.5mmD x 2mmL	26
WP0091	WP Conical Healing Abutment 5.5mmD x 3mmL	26
WP0092	WP Conical Healing Abutment 5.5mmD x 4mmL	26
WP0093	WP Conical Healing Abutment 5.5mmD x 5mmL	26
WP0094	WP Conical Healing Abutment 5.5mmD x 6mmL	26
WP3095	WP Engaging Titanium / Plastic Abutment	26
WP3097	WP Non-Engaging Titanium / Plastic Abutment	26
WP3401	WP Retrieval Screw for Abutments	29,66
WP3403	WP Retaining Screw for Angled TMA	29
WP3406	WP Retaining Screw for TMA 1mm	29
WP3407	WP Retaining Screw for TMA 2mm	29
WP3408	WP Retaining Screw for TMA 3mm	29
WP3409	WP Retaining Screw for TMA 4mm	29
WP3412	WP Retaining Screw for TMA 5mm	29
WP3729	WP Straight Trans Mucosal Abutment 4mm	27
WP3730	WP Straight Trans Mucosal Abutment 5mm	27
WP3731	WP Straight Trans Mucosal Abutment 1mm	27
WP3732	WP Straight Trans Mucosal Abutment 2mm	27
WP3733	WP Straight Trans Mucosal Abutment 3mm	27
WP3734	WP Angled Trans Mucosal Abutment 17° 2.5mm	27
WP3735	WP Angled Trans Mucosal Abutment 30° 3mm	27
WP3737	WP Angled Trans Mucosal Abutment 17° 3.5mm	27
WP3738	WP Angled Trans Mucosal Abutment 30° 4mm	27
WP5010	WP Open Tray Transfer Screw - Short	29
WP5014	WP Open Tray Transfer Screw - Long	29
WP5109	WP Slim Closed Tray Transfer 4mmDx9mmL	28
WP5113	WP Slim Closed Tray Transfer 4mmDx13mmL	28
WP5126	WP Closed Tray Transfer Screw - Short	29
WP5127	WP Closed Tray Transfer Screw - Long	29
WP5209	WP Closed Tray Transfer 5.2mmDx9mmL	28
WP5213	WP Closed Tray Transfer 5.2mmDx13mmL	28
WP5309	WP Wide Closed Tray Transfer 6mmDx9mmL	28
WP5313	WP Wide Closed Tray Transfer 6mmDx13mmL	28
WP5410	WP Wide Open Tray Transfer 6mmDx10mmL	28
WP5414	WP Wide Open Tray Transfer 6mmDx14mmL	28
WP5510	WP Open Tray Transfer 5.2mmDx10mmL	28
WP5514	WP Open Tray Transfer 5.2mmDx14mmL	28
WP5610	WP Slim Open Tray Transfer 4mmDx10mmL	28
WP5614	WP Slim Open Tray Transfer 4mmDx14mmL	28

ADIN products meet the highest standards set by the FDA and other regulatory agencies.

All ADIN products are CE-marked in accordance with the Council Directive 93/42/EEC and Amendment 2007/47/EC.

ADIN complies with EN ISO13485:2012 and the Canadian Medical Devices Conformity Assessment System (CMDCAS).

Product availability may vary between countries.

For more information, please contact your local ADIN office.

www.adin-implants.com



Industrial Park Alon Tavor, POB 1128, Afula 1811101, Israel
T. +972-4-6426732 | F. +972-4-6426733 | info@adin-implants.com